



High Performance Bike Components

Index

FRAME	6	V-BRAKE	33	SPACER	50
STEM	8	CANTI BRAKE	34	CHAIN RING	52
MTB STEM	11	LEVER	35	COG	54
DOWNHILL STEM	14	BRAKE PADS	36	ACCESSORIES	56
RACING HANDLEBARS	16	CHAIN GUIDE	38	BOLT	58
MTB HANDLEBARS	18	BASH GUARD	41	VALVE EXTENDER	60
SEATPOST	20	TRI-BAR	42	VALVE CAP	61
CLAMP	22	ACCESSORIES	43	TOOL	63
QUICK RELEASE	27	TOP CAP	46		
ROAD BRAKE	32	HEAD ACCESSORIES	48		



ABOUT US

We are a group of bike riders and a family firm of engineers. We ride bikes and we know what's the best product for the riders. We have more than ten years of experience on the CNC machine works and enriched our knowledge of the material, we know what is most strong, light and stable material for the Bike Parts. Most of our products are made of strong alloy, carbon and the worldwide well-known plastic raw materials from Swiss.

All of our products are made in Taiwan, that's because we know the quality issue is the most important for all customers, because of our great passion on the bike products, we just have a desire to be a world-class supplier, to develop and fabricate the best bicycle components.

FRAME

FR-S001



MODEL	MODELS	COLOR	WEIGHT	FEATURES
FR-S001-470	RACING	FOURIERS PAINTING		Size: 47mm
FR-S001-500	RACING	FOURIERS PAINTING		Size: 50mm
FR-S001-520	RACING	FOURIERS PAINTING		Size: 52mm
FR-S001-540	RACING	FOURIERS PAINTING		Size: 54mm
FR-S001-560	RACING	FOURIERS PAINTING		Size: 56mm
FR-S001-580	RACING	FOURIERS PAINTING		Size: 58mm
FR-S001-610	RACING	FOURIERS PAINTING		Size: 61mm

Most progressive design For wind resistance concern, we designed the frame to hide the brake at the rear of the fork and under the Bottom Bracket.

The 1-1/8 ~ 1-1/2 head tube can be handling easier & efficiently promote the stiffness of the frame. And, extra big on Bottom Bracket and seat tube to get better stiff than the traditional frames. To look for a low wind resistance and high stiff frame, this is the best choice.

Parts include:

- Brake
- Seat clamp
- Headset

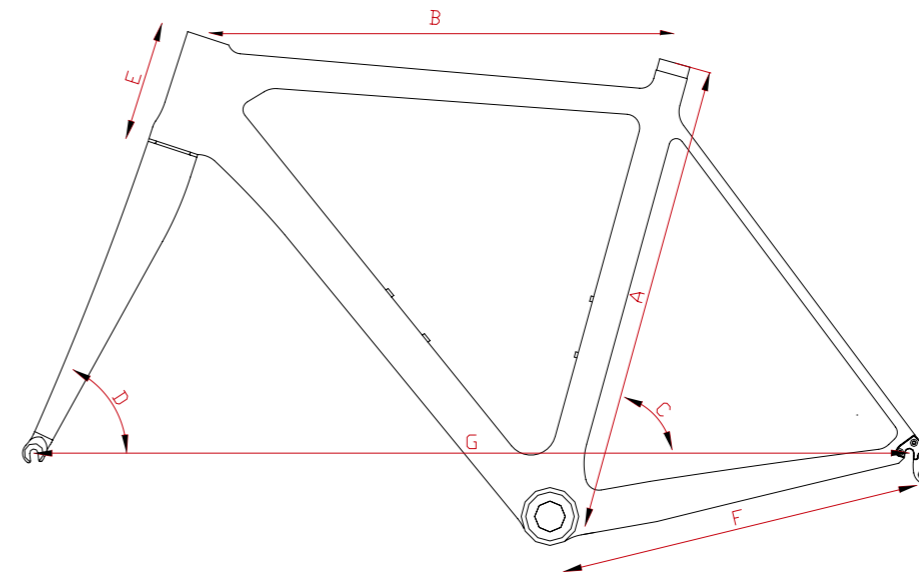

車架幾何

SIZE	A(mm)	B(mm)	C(mm)	D(mm)	E(mm)	F(mm)	G(mm)
47	470	500	75	71.5	105	406	954.9
50	500	514.5	75	72	120	406	966.6
52	520	526.7	74.5	72	130	406	974.4
54	540	539.4	74	72.5	145	406	977.9
56	560	557.8	73.5	72.5	155	406	991.3
58	580	567.9	73.5	73	170	406	996.8
61	610	590	73	73	200	408	1015.5

STEM

SM-RA001

Full CNC made, unique light weight.
Alloy 6066 material effectively enhance the overall strength and improve hard to stress corrosion.
Bar bore size upgrade to Ø35mm conget more siffness with Ø35mm handlebar.
80-140Mm lenght, 7 size can choice.
Has been approved by EN test standards.

Product Features:

- Material: Alloy 6066-T6
- Spec: 80~140mm
- Angle: ±8 degree
- Fork stack hight 40mm fork tube 31.8mm
- Handlebar clamp 35mm

- Weight: 80mm/131g
- 90mm/135g
- 100mm/137g
- 110mm/141.5g
- 120mm/146g
- 130mm/151g
- 140mm/156g

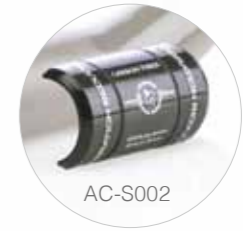
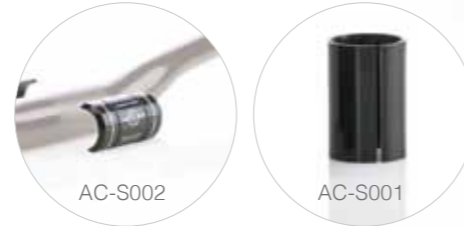

MODEL	MODELS	COLOR	WEIGHT	FEATURES
SM-RA001-801	ROAD or MTB	BLACK	131.0g/pcs	DEGREE: ±8° / LENGTH: 80mm For Fork 1-1/4" / Bar-bore 35mm / With carbon shim
SM-RA001-901	ROAD or MTB	BLACK	135.0g/pcs	DEGREE: ±8° / LENGTH: 90mm For Fork 1-1/4" / Bar-bore 35mm / With carbon shim
SM-RA001-1001	ROAD or MTB	BLACK	137.0g/pcs	DEGREE: ±8° / LENGTH: 100mm For Fork 1-1/4" / Bar-bore 35mm / With carbon shim
SM-RA001-1101	ROAD or MTB	BLACK	141.5g/pcs	DEGREE: ±8° / LENGTH: 110mm For Fork 1-1/4" / Bar-bore 35mm / With carbon shim
SM-RA001-1201	ROAD or MTB	BLACK	146.0g/pcs	DEGREE: ±8° / LENGTH: 120mm For Fork 1-1/4" / Bar-bore 35mm / With carbon shim
SM-RA001-1301	ROAD or MTB	BLACK	151.0g/pcs	DEGREE: ±8° / LENGTH: 130mm For Fork 1-1/4" / Bar-bore 35mm / With carbon shim
SM-RA001-1401	ROAD or MTB	BLACK	156.0g/pcs	DEGREE: ±8° / LENGTH: 140mm For Fork 1-1/4" / Bar-bore 35mm / With carbon shim

FRF (Frequency Response Function) Experimental Results:

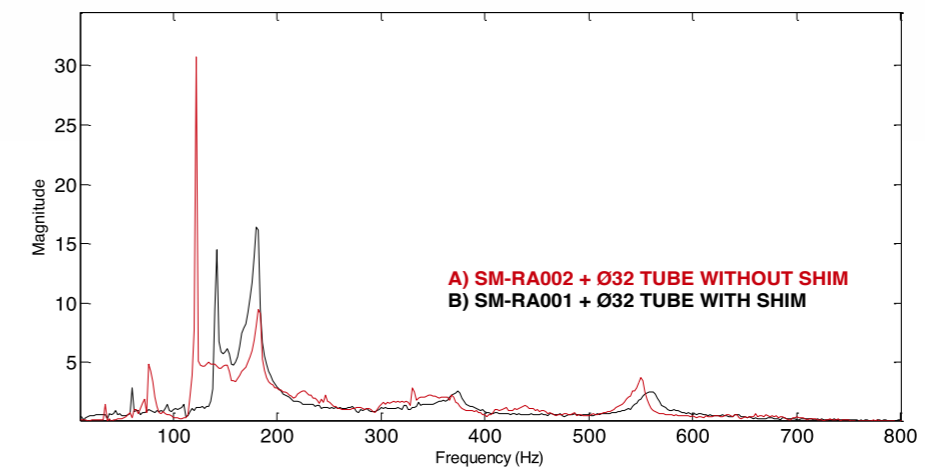

Results: The stem without shim has a resonant peak as high as 31 in magnitude at 122 Hz. Whereas the stem with shim has a resonant peak of only 15 in magnitude at 140 Hz. The result indicates that the stem with shim will have smaller vibration amplitudes.

Time Waveform Chart Experimental Results:

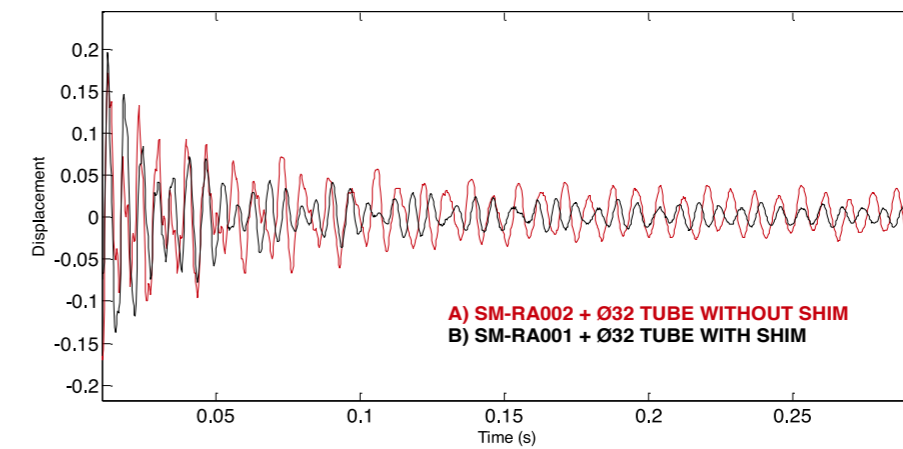

Results: Initially, the amplitudes of the waveforms of both stems are almost the same. However, the amplitude of the stem with shim decays faster. After 0.05 seconds, the amplitude of the stem with shim is smaller than that of the stem without shim.

STEM

SM-RA002

Full CNC made, unique light weight stem.
Alloy 6066 material effectively enhance the overall strength to eliminate stress corrosion.
80mm ~ 140mm total 7 sizes.
Has been approved by EN test standards.

Product Features:

- Material: Alloy 6066-T6
- Spec: 80~140mm
- Angle: ±6 degree
- Fork stack height 40mm fork tube 28.6mm
- Handlebar clamp 31.8mm
- Weight: 80mm/122g
90mm/124g
100mm/128.5g
110mm/131.5g
120mm/138.5g
130mm/140g
140mm/145g



MODEL	MODELS	COLOR	WEIGHT	FEATURES
SM-RA002-801	ROAD or MTB	BLACK	122.0g/pcs	DEGREE: ±6° / LENGTH: 80mm For Fork 1-1/8" / Bar-bore 31.8mm
SM-RA002-901	ROAD or MTB	BLACK	124.0g/pcs	DEGREE: ±6° / LENGTH: 90mm For Fork 1-1/8" / Bar-bore 31.8mm
SM-RA002-1001	ROAD or MTB	BLACK	128.5g/pcs	DEGREE: ±6° / LENGTH: 100mm For Fork 1-1/8" / Bar-bore 31.8mm
SM-RA002-1101	ROAD or MTB	BLACK	131.5g/pcs	DEGREE: ±6° / LENGTH: 110mm For Fork 1-1/8" / Bar-bore 31.8mm
SM-RA002-1201	ROAD or MTB	BLACK	138.5g/pcs	DEGREE: ±6° / LENGTH: 120mm For Fork 1-1/8" / Bar-bore 31.8mm
SM-RA002-1301	ROAD or MTB	BLACK	140.0g/pcs	DEGREE: ±6° / LENGTH: 130mm For Fork 1-1/8" / Bar-bore 31.8mm
SM-RA002-1401	ROAD or MTB	BLACK	145.0g/pcs	DEGREE: ±6° / LENGTH: 140mm For Fork 1-1/8" / Bar-bore 31.8mm

MTB STEM

SM-MB004

Full CNC made, simple & economic.
Has been approved by EN test standards.

Product Features:

- Material: Alloy 6066 T6
- Spec: 50~140mm
- Angle: 0 degree
- Fork stack high 40mm fork tube 31.8mm
- Handlebarclamp 35mm
- With SHIM (AC-S001) - fork tube Ø31.8 change to Ø28.6
SHIM (AC-S002) - handlebar clamp Ø35 change to Ø31.8
- Weight: 50mm/132g
60mm/155g
70mm/178g
80mm/191g
90mm/210g
100mm/228g
110mm/245g
120mm/263g
130mm/282g
140mm/298g

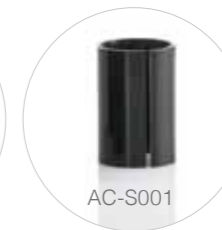

MODEL	MODELS	COLOR	WEIGHT	FEATURES
SM-MB004	MTB	BLACK	132g~298g/pcs	DEGREE: 0° / LENGTH: 50 ~ 140mm For Fork 1-1/4" / Bar-bore 35mm / With carbon shim

MTB STEM

SM-MB001

Full CNC made, unique light weight.
Extra big barbore Ø35mm for extra strength.
Has been approved by EN test standards.

Product Features:

- Material: Alloy 6061-T6
- Angle: 0 degree
- Length: 50mm
- Fork stack high 40mm fork tube 31.8mm
- Handlebar clamp 35mm
- With SHIM (AC-S001) - fork tube Ø31.8 change to Ø28.6
SHIM (AC-S002) - handlebar clamp Ø35 change to Ø31.8
- Weight: 205g

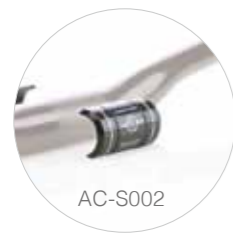

AC-S002



AC-S001



MODEL	MODELS	COLOR	WEIGHT	FEATURES
SM-MB001-501	DOWNHILL / FREE RIDE / 4X	BLACK	205.0g/pcs	DEGREE: 0° / LENGTH: 50mm For Fork 1-1/4" / Bar-bore 35mm / With carbon shim

SM-MB002

CNC machined.
Extra big barbore 35mm for extra strength.
Has been approved by EN test standards.

Product Features:

- Material: Alloy 6061-T6
- Angle: 0 degree
- Length: 40-70mm
- Fork stack high 40mm fork tube 31.8mm
- Handlebar clamp 35mm
- With SHIM (AC-S001) - fork tube Ø31.8 change to Ø28.6
SHIM (AC-S002) - handlebar clamp Ø35 change to Ø31.8
- Weight: 40mm/139.5g
50mm/154.5g
60mm/173.5g
70mm/175g



AC-S002



AC-S001



MODEL	MODELS	COLOR	WEIGHT	FEATURES
SM-MB002-401	MTB	BLACK	139.5g/pcs	DEGREE: 0° / LENGTH: 40mm For Fork 1-1/4" / Bar-bore 35mm / With carbon shim
SM-MB002-501	MTB	BLACK	154.5g/pcs	DEGREE: 0° / LENGTH: 50mm For Fork 1-1/4" / Bar-bore 35mm / With carbon shim
SM-MB002-601	MTB	BLACK	173.5g/pcs	DEGREE: 0° / LENGTH: 60mm For Fork 1-1/4" / Bar-bore 35mm / With carbon shim
SM-MB002-701	MTB	BLACK	175.0g/pcs	DEGREE: 0° / LENGTH: 70mm For Fork 1-1/4" / Bar-bore 35mm / With carbon shim

DOWNHILL STEM

SM-MB003

Full CNC made, unique light weight.
Bar bore size upgrade to Ø35mm can get more stiffness with Ø35mm handlebar.

To fix the downhill fork.

Has been approved by EN test standards.

Product Features:

- Material: Alloy 6061-T6
- Offset height: 25mm
- Direct mount: boxxer
- Handlebar clamp 35mm
- With SHIM (AC-S002) - handlebar clamp Ø35 change to Ø31.8
- Weight: 171g



AC-S002



MODEL	MODELS	COLOR	WEIGHT	FEATURES
SM-MB003-001	DOWNHILL	BLACK	171.0g/pcs	Offset height: 25mm / Bar-bore 35mm Direct mount: boxxer / With carbon shim
SM-MB003-005	DOWNHILL	GRAY	171.0g/pcs	Offset height: 25mm / Bar-bore 35mm Direct mount: boxxer / With carbon shim

HA-S007

Adjust handlebar Height / Easy to change the riding position
/ With screw, cap and spacer.

Product Features:

- Steering tube exted for Ø28.6 fork
- Material: Alloy 6061-T6 body, Top cap, Spacer / Alloy 7075 long screw
- Length: 50mm (Adjust height 47.5mm ~ 65.5mm)
90mm (Adjust height 47.5mm ~ 105.5mm)
120mm (Adjust height 47.5mm ~ 135.5mm)
- Color: Sandblast black anodize
- Weight: 154g/set (50mm) / 192g/set (90mm) / 230g/set (120mm)

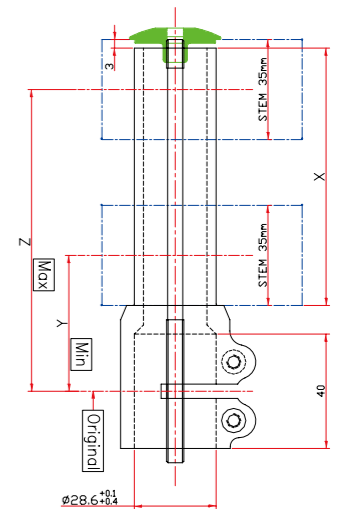

X	Y	Z
50	47.5	65.5
90	47.5	105.5
120	47.5	135.5

MODEL	MODELS	COLOR	WEIGHT	FEATURES
HA-S007-5101	All models	S.B BLACK	154g/set	Adjust height 47.5mm ~ 65.5mm / With long screw, spacer & cap
HA-S007-9101	All models	S.B BLACK	192g/set	Adjust height 47.5mm ~ 105.5mm / With long screw, space & cap
HA-S007-12101	All models	S.B BLACK	230g/set	Adjust height 47.5mm ~ 135.5mm / With long screw, spacer & cap

RACING HANDLEBARS

HB-RA001 **31.8** CARBON

One piece monocoque construction.
Passed safety test.
Fluid mechanics design on bar top to reduce drag / increase the hand-hold area.
Lower bar area to use anatomic ratio design for sprint position.

Product Features:

- Material: Carbon fiber
- Spec: 31.8mm x W400, 420, 440mm (c-c)
- Drop: 130mm
- Reach: 80mm
- Bar type: anatomic-bend
- Weight: 216g (W420mm)

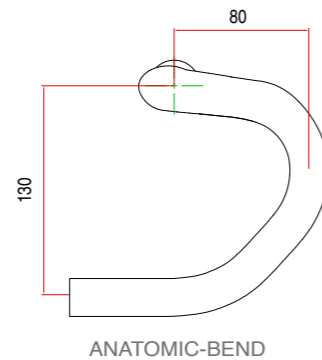

HB-RA002 **31.8** CARBON

One piece monocoque construction.
Passed safety test.
Ergonomic design for more comfortable.
Lower bar area to use compact ratio design for sprint position.

Product Features:

- Material: Carbon fiber
- Spec: 31.8mm x W400, 420, 440mm (c-c)
- Drop: 130mm
- Reach: 80mm
- Bar type: compact
- Weight: 216g (W420mm)

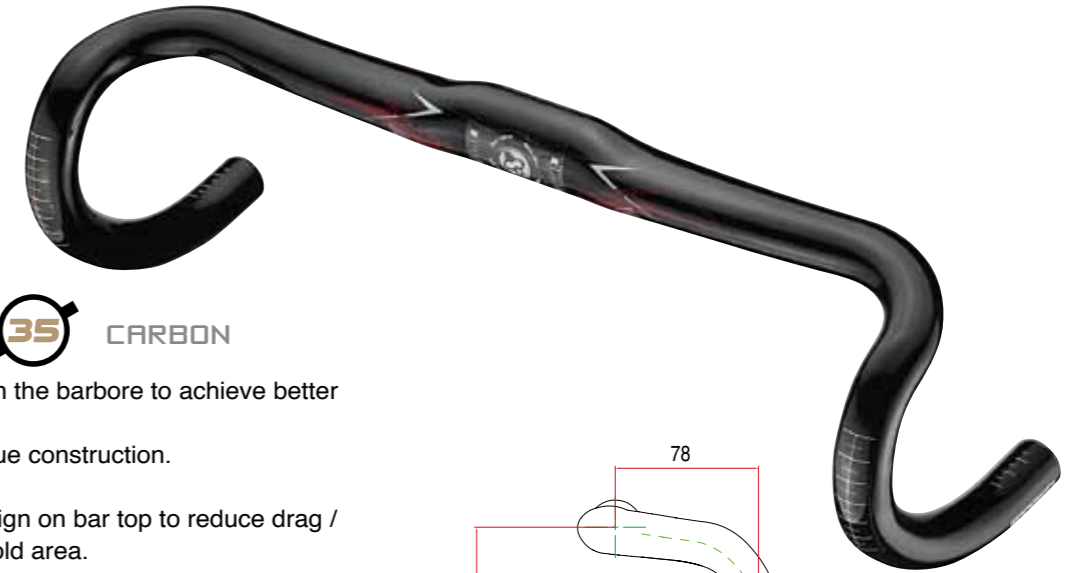
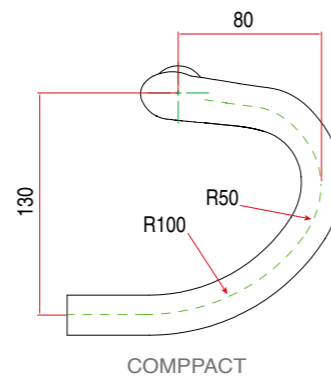

HB-RA003 **35** CARBON

Extra big diameter on the bar bore to achieve better strength.
One piece monocoque construction.
Passed safety test.
Fluid mechanics design on bar top to reduce drag / increase the hand-hold area.
Lower bar area to use compression ratio design for multiple hand-hold position.

Product Features:

- Material: Carbon fiber
- Spec: 35mm x W400, 420, 440mm (c-c)
- Drop: 128mm
- Reach: 78mm
- Bar type: compact
- Weight: 225g (W420mm)

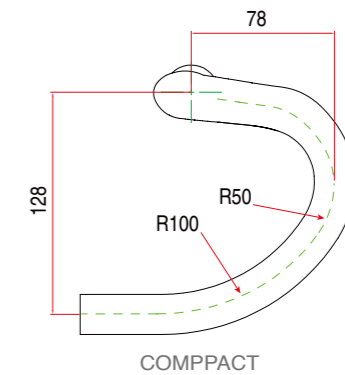

MODEL	MODELS	COLOR	WEIGHT	FEATURES
HB-RA001-400	RACING	CARBON UD	216.0g	Bar-bore Ø31.8mm x W400mm (c-c) RISE: 130mm / REACH: 80mm / Bar tpye: Anatomic-bend
HB-RA001-420	RACING	CARBON UD	220.0g	Bar-bore Ø31.8mm x W400mm (c-c) RISE: 130mm / REACH: 80mm / Bar tpye: Anatomic-bend
HB-RA001-440	RACING	CARBON UD	225.0g	Bar-bore Ø31.8mm x W440mm (c-c) RISE: 130mm / REACH: 80mm / Bar tpye: Anatomic-bend
HB-RA002-400	RACING	CARBON UD	216.0g	Bar-bore Ø31.8mm x W400mm (c-c) RISE: 130mm / REACH: 80mm / Bar tpye: Compact
HB-RA002-420	RACING	CARBON UD	220.0g	Bar-bore Ø31.8mm x W420mm (c-c) RISE: 130mm / REACH: 80mm / Bar tpye: Compact
HB-RA002-440	RACING	CARBON UD	225.0g	Bar-bore Ø31.8mm x W420mm (c-c) RISE: 130mm / REACH: 80mm / Bar tpye: Compact
HB-RA003-400	RACING	CARBON UD	225.0g	Bar-bore Ø35mm x W400mm (c-c) RISE: 128mm / REACH: 78mm / Bar tpye: Compact
HB-RA003-420	RACING	CARBON UD	230.0g	Bar-bore Ø35mm x W420mm (c-c) RISE: 128mm / REACH: 78mm / Bar tpye: Compact
HB-RA003-440	RACING	CARBON UD	235.0g	Bar-bore Ø35mm x W440mm (c-c) RISE: 128mm / REACH: 78mm / Bar tpye: Compact

MTB HANDLEBARS



HB-MB001 35 CARBON



HB-MB002 31.8 CARBON



HB-MB003 35 ALLOY



HB-MB004 31.8 ALLOY



HB-MB007 31.8 ALLOY



HB-MB008 31.8 CARBON

HB-MB001 35 CARBON

One piece monocoque construction. Enlarge diameter at stem clamping area to get better strength. Extra width can efficiently increase stability control. Can adjust the width to min 660mm. Passed safety test.

- Product Features:
- Material: Carbon fiber
 - Spec: 35mm x W780mm
 - Rise: 20mm
 - Back sweep: 9 degree
 - Up sweep: 5 degree
 - Weight: 279g

HB-MB002 31.8 CARBON

One piece monocoque construction. Extra width can efficiently increase stability control. Can adjust the width to min. 660mm. Passed safety test.

- Product Features:
- Material: Carbon fiber
 - Spec: 31.8mm x W780mm
 - Rise: 20mm
 - Back sweep: 9 degree
 - Up sweep: 5 degree
 - Weight: 273g

HB-MB003 35 ALLOY

Made of special material Alloy 6066 and double butted, stronger than Alloy 6061 and have anti-stress corrosion, better than 7000 series. Extra width can efficiently increase stability control. Can adjust the width to min. 660mm. Special design for free ride & downhill. Passed safety test.

- Product Features:
- Material: Alloy 6066-T6
 - Spec: 35mm x W780mm
 - Rise: 20mm
 - Back sweep: 9 degree
 - Up sweep: 5 degree
 - Weight: 427.5g

HB-MB004 31.8 ALLOY

Made of special material Alloy 6066 and double butted, stronger than Alloy 6061 and have anti-stress corrosion, better than 7000 series. Extra width can efficiently increase stability control. Can adjust the width to min. 660mm. Special design for free ride & downhill. Passed safety test.

- Product Features:
- Material: Alloy 6066-T6
 - Spec: 31.8mm x W780mm
 - Rise: 20mm
 - Back sweep: 9 degree
 - Up sweep: 5 degree
 - Weight: 382g

HB-MB007 31.8 ALLOY

Made of Alloy 6066 material and hydroforming, can increase strength and decrease the risk of stress corrosion. **Eccentric design to adjust the angle +/-5mm.** Passed safety test.

- Product Features:
- Material: Alloy 6066-T6
 - Spec: 31.8mm x W720mm
 - **Eccentric: 5mm**
 - Back sweep: 9 degree
 - Weight: 235g

HB-MB008 31.8 CARBON

The best 9 degree bend angle design to make you more comfortable on ride. Advanced material effectively absorb the uneven road surface vibration. Eccentric design can change height of 5mm to reduce the height of handlebar, it's the best choice to make your bike more light on riding. Passed safety test.

- Product Features:
- Material: Carbon fiber
 - Spec: Ø31.8mm x W750mm
 - **Eccentric: 5mm**
 - Back sweep: 9 degree
 - Weight: 170g

MODEL	MODELS	COLOR	WEIGHT	FEATURES
HB-MB001-350	MTB	CARBON UD	279.0g	Bar-bore Ø35mm x W780mm OFFSET: 20mm / Back Sweep: 9° / Up Sweep: 5°
HB-MB002-320	MTB	CARBON UD	273.0g	Bar-bore Ø31.8mm x W780mm OFFSET: 20mm / Back Sweep: 9° / Up Sweep: 5°
HB-MB003	MTB	BLACK / SILVER RED	427.5g	Bar-bore Ø35mm x W780mm OFFSET: 20mm / Back Sweep: 9° / Up Sweep: 5°
HB-MB004	MTB	BLACK / SILVER RED	382.0g	Bar-bore Ø31.8mm x W780mm OFFSET: 20mm / Back Sweep: 9° / Up Sweep: 5°
HB-MB007	MTB	BLACK / SILVER RED	235.0g	Bar-bore Ø31.8mm x W720mm Offset 5mm / Back Sweep: 9°
HB-MB008-320	MTB	CARBON UD	170.0g	Bar-bore Ø31.8mm x W750mm Offset 5mm / Back Sweep: 9°

SEATPOST

The carbon fiber clamp on seat post would let you feel comfortable when riding, if you don't want to have the saddle rails destroyed by metal clamp, our seatpost is the best choice.



For DI2 battery holder

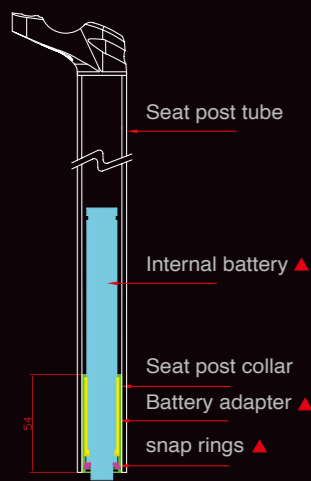

▲ SHIMANO parts



SP-S001
SP-S001-DI2
CARBON

One piece monocoque carbon tube.
One piece monocoque carbon top clamp.
Double bolt design.

Product Features:

- Material: UD Carbon fiber
- Spec: Ø27.2mm or Ø31.6mm
- Length: 350mm or 400mm
- Setback: 20mm
- Weight: 200g (Ø31.6 350mm)



SP-S002
SP-S002-DI2
CARBON

Carbon fiber seat post is the one of the best choice to reduce the road vibration, it would be the best choice too if you use carbon fiber saddle rail, this seat post can protect the saddle carbon rail efficiently.

Product Features:

- Material: Alloy 6061-T6 body
UD Carbon tube
Carbon saddle clamp
- Spec: Ø27.2, Ø30.9, Ø31.6
- Length: 300 / 350 / 400mm
- Offset: 20mm
- Weight: 235g (Ø31.6 350mm)



SP-E001
SP-E001-DI2
ALLOY

Good looking high strength alloy seat post, double screw locking for angle adjustment.

Product Features:

- Material: Alloy 6061-T6 body
Alloy 6066-T6 tube
Alloy 6061-T6 saddle clamp
- Spec: Ø27.2, Ø31.6
- Length: 300 / 350 / 400mm
- Offset: 20mm
- Color: Sandblast black anodized
- Weight: 310g (Ø31.6 350mm)

MODEL	MODELS	COLOR	WEIGHT	FEATURES
SP-S001	MTB / RACING	CARBON UD	187g~213g	OD: Ø27.2mm or Ø31.6mm / LENGTH: 350mm or 400mm / OFFSET: 20mm
SP-S001-DI2	MTB / RACING	CARBON UD	187g~213g	OD: Ø27.2mm or Ø31.6mm / LENGTH: 350mm or 400mm / OFFSET: 20mm
SP-S002	MTB / RACING	CARBON UD	227g~260g	OD: Ø27.2mm or Ø31.6mm / LENGTH: 350mm or 400mm / OFFSET: 20mm
SP-S002-DI2	MTB / RACING	CARBON UD	227g~260g	OD: Ø27.2mm or Ø31.6mm / LENGTH: 350mm or 400mm / OFFSET: 20mm
SP-E001	MTB / RACING	BLACK	310g~353g	OD: Ø27.2mm or Ø31.6mm / LENGTH: 350mm or 400mm / OFFSET: 20mm
SP-E001-DI2	MTB / RACING	BLACK	310g~353g	OD: Ø27.2mm or Ø31.6mm / LENGTH: 350mm or 400mm / OFFSET: 20mm



The carbon clamp tighten torque please follow the warning sticker

CLAMP



SCL-S001

Double M5 bolt.
Chamfer edge & oval hole design to protect carbon frame & seatpost.
With rubber cover to prevent dust and water get into seat tube.



Product Features:

- Bolt Type seatpost clamp CNC Machined
- Polished anodized finish
- Material: Alloy 6066-T6
- Spec: Ø31.8 (Fix Ø27.2 Seatpost) / Ø34.9 (Fix Ø31.6 Seatpost)
- Height: 17.5mm
- Weight: (Ø31.8) 24g / (Ø34.9) 27g
- Color: black, silver, red, gray

SCL-S002

Double M5 bolt.
Chamfer edge & oval hole design to protect carbon frame.

Product Features:

- Bolt Type seatpost clamp CNC Machined
- Polished anodized finish
- Material: Alloy 6066-T6
- Spec: Ø31.8 or Ø34.9
- Height: 20mm
- Weight: (Ø31.8) 25g / (Ø34.9) 28g
- Color: black, silver, red, gray



SCL-S003 CARBON

Light weight design high end look / CNC Titanium bolt / Full UD carbon.



Product Features:

- Material: Carbon / Double Titanium M4 x 18mm bolt
- Spec: Ø31.8, Ø34.9
- Height: 12mm
- Weight: 14g

MODEL	MODELS	COLOR	WEIGHT	FEATURES
SCL-S001	All models	BLACK / SILVER RED / GRAY	24g~27g	Seat tube Ø31.8mm & Seatpost Ø27.2mm or Seat tube Ø34.9mm & Seatpost Ø31.6mm
SCL-S002	All models	BLACK / SILVER RED / GRAY	25g~28g	Seat tube Ø31.8mm or Seat tube Ø34.9mm
SCL-S003-300	All models	CARBON UD	12g~14g	Seat tube Ø31.8mm or Seat tube Ø34.9mm

CLAMP



SCL-E001

Independent special nut design allows screws in the lock can automatically adjust the angle to prevent the deformation problem of stresses concentration.

Product Features:

- Bolt type seatpost clamp CNC Machined
- Polished anodized or Sandblasted anodized finish
- Material: Alloy 6061-T6
- Spec: Ø31.8, Ø34.9
- Height: 11mm
- Weight: (Ø31.8) 22.5g / (Ø34.9) 23.2g
- Color: black, silver

SCL-E002

Economic seatclamp / classic design.

Product Features:

- Bolt type seatpost clamp CNC Machined
- Polished anodized or Sandblasted anodized finish
- Material: Alloy 6061-T6
- Spec: Ø31.8, Ø34.9
- Height: 11mm
- Weight: (Ø31.8) 20.2g / (Ø34.9) 22.5g
- Color: black, silver



SCL-E003

Chamfer edge & oval hole design to protect carbon frame / Classic design.

Product Features:

- Polished anodized
- Material: Alloy 6061-T6
- Spec: Ø31.8, Ø34.9
- Height: 15mm
- Weight: (Ø31.8) 22g / (Ø34.9) 23.5g
- Color: black, silver, red, gray

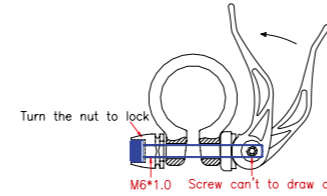

SCL-QE001(P.A.T)

This screw can't be disassembled as it's being made with a special procedure before assembling, to reduce the probability of having the things been stolen.

Product Features:

- QR & Bolt Type seatpost clamp CNC Machined
- Sandblast anodized finish
- Material: Alloy 6061-T6
- Spec: Ø31.8 or Ø34.9
- Height: 13.5mm
- Weight: (Ø31.8) 56g / (Ø34.9) 59g
- Color: black, silver

SCL-QX001

Seat clamp with ultra-lightweight Quick Release. Perfect combination with the ultra light weight QR. Chamfer edge & oval hole design to protect carbon frame.

Product Features:

- QR-Type Seatpost clamp CNC Machined
- Polished anodized finish
- Material: Alloy 6061-T6
- Washer material: thermal plastic carbon 40%
- Spec: Ø31.8 or Ø34.9
- Height: 16mm
- Weight: (Ø31.8) 28g / (Ø34.9) 30.5g
- Color: black, silver



SCL-QX002

Seat clamp with ultra-lightweight Quick Release. Perfect combination with the ultra light weight QR. Chamfer edge & oval hole design to protect carbon frame.

Product Features:

- QR-Type Seatpost clamp CNC Machined
- Polished anodized finish
- Material: Alloy 6061-T6
- Washer material: thermal plastic carbon 40%
- Spec: Ø31.8 or Ø34.9
- Height: 16mm
- Weight: (Ø31.8) 26g / (Ø34.9) 29g
- Color: black, silver



MODEL	MODELS	COLOR	WEIGHT	FEATURES
SCL-E001	All models	BLACK / SILVER S.B Black / S.B SILVER	22.5g~23.2g	Seat tube Ø31.8mm or Seat tube Ø34.9mm
SCL-E002	All models	BLACK / SILVER S.B Black / S.B SILVER	20.2g~22.5g	Seat tube Ø31.8mm or Seat tube Ø34.9mm
SCL-E003	All models	BLACK / SILVER / RED / GRAY	22g~23.5g	Seat tube Ø31.8mm or Seat tube Ø34.9mm

MODEL	MODELS	COLOR	WEIGHT	FEATURES
SCL-QE001	All models	S.B BLACK / S.B SILVER	56g~59g	Seat tube Ø31.8mm or Seat tube Ø34.9mm
SCL-QX001	All models	BLACK / SILVER	28g~31g	Seat tube Ø31.8mm or Seat tube Ø34.9mm
SCL-QX002	All models	BLACK / SILVER	26g~29g	Seat tube Ø31.8mm or Seat tube Ø34.9mm

CLAMP



SCL-QE001-S(P.A.T)

Do you worry about the seatpost on your bike is stolen? As long as this product is installed inside of the seatpost and collocates with the seat clamp SCL-QE001 to ensure the thief must not steal the seatpost in a short time.

Product Features:

- QR & Bolt Type seatpost clamp CNC Machined
- Safety steel cable wire
- Seatclamp: Sandblast anodize
- Material: Main alloy 6061-T6
- Spec: Ø31.8 or Ø34.9
- Weight: (Ø31.8) 110g/set / (Ø34.9) 113g/set
- Clamp color: black, silver

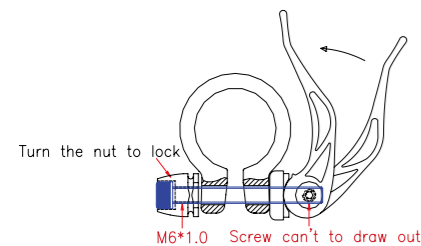

MODEL	MODELS	COLOR	WEIGHT	FEATURES
SCL-QE001-S311	All models	S.B BLACK	110g/set	Seat tube Ø31.8mm / With anti-theft system
SCL-QE001-S312	All models	S.B SILVER	110g/set	Seat tube Ø31.8mm / With anti-theft system
SCL-QE001-S411	All models	S.B BLACK	113g/set	Seat tube Ø34.9mm / With anti-theft system
SCL-QE001-S412	All models	S.B SILVER	113g/set	Seat tube Ø34.9mm / With anti-theft system

QUICK RELEASE

QR-DX001 CARBON LEVER / Titanium Axle

Super lightweight quick release, titanium axle, alloy body & carbon lever bonded perfectly.

Product Features:

- Alloy with carbon fiber lever
- Cap washer and nut anodized finish
- Titanium axle ED black finish
- With FOURIERS logo
- Weight: 43g/set (RACING) / 46g/set (MTB)
- Color available: black, silver, red, gold, gray
- For RACING or MTB



MODEL	MODELS	COLOR	WEIGHT	FEATURES
QR-DX001-001	RACING	BLACK	43g/set	O.L.D: (F)100mm (R)130mm
QR-DX001-002	RACING	SILVER	43g/set	O.L.D: (F)100mm (R)130mm
QR-DX001-003	RACING	RED	43g/set	O.L.D: (F)100mm (R)130mm
QR-DX001-004	RACING	GOLD	43g/set	O.L.D: (F)100mm (R)130mm
QR-DX001-005	RACING	GRAY	43g/set	O.L.D: (F)100mm (R)130mm
QR-DX001-101	MTB	BLACK	46g/set	O.L.D: (F)100mm (R)135mm
QR-DX001-102	MTB	SILVER	46g/set	O.L.D: (F)100mm (R)135mm
QR-DX001-103	MTB	RED	46g/set	O.L.D: (F)100mm (R)135mm
QR-DX001-104	MTB	GOLD	46g/set	O.L.D: (F)100mm (R)135mm
QR-DX001-105	MTB	GRAY	46g/set	O.L.D: (F)100mm (R)135mm

QUICK RELEASE

QR-S001 Titanium Axle

Lightweight design aluminum with quick release.
Perfect combination with the ultra lightweight lever.

Product Features:

- Alloy full CNC machined lever
- Cap washer and nut anodized finish
- **Titanium** axle ED black finish
- With FOURIERS logo
- **Weight: 45g/set (RACING) / 47g/set (MTB)**
- Color available: black, silver, red, gold, gray
- For RACING or MTB



QR-S002 Titanium Axle

Lightweight design aluminum with quick release.
Perfect combination with the ultra lightweight Lever.

Product Features:

- Alloy full CNC machined lever
- Cap washer and nut anodized finish
- **Titanium** axle ED black finish
- With FOURIERS logo
- **Weight: 53.0g/set (RACING) / 56.0g/set (MTB)**
- Color available: black, silver, red, gold, gray
- For RACING or MTB



MODEL	MODELS	COLOR	WEIGHT	FEATURES
QR-S001	RACING or MTB	BLACK / SILVER / RED GOLD / GRAY	45g/set~47g/set	O.L.D: (F)100mm (R)130mm or 135mm
QR-S002	RACING or MTB	BLACK / SILVER / RED GOLD / GRAY	53g/set~56g/set	O.L.D: (F)100mm (R)130mm or 135mm

QR-S003

Alloy full CNC machined lever.
The high intensity both lightweight and art products.

Product Features:

- Alloy lever made anodized finish
- Cap washer and nut made anodize color
- Alloy 7075-T6 12mm axle made anodize color
- With FOURIERS logo
- For 142mm HUB
- Fix SHIMANO 12mm HUB



QR-E001

Economic quick release / classic design.

Product Features:

- Alloy lever made anodized finish
- 10B21 axle
- With FOURIERS logo
- **Weight: 112g/set (RACING) / 115g/set (MTB)**
- Color: Sandblast black or silver anodize
- For Racing or MTB



MODEL	MODELS	COLOR	WEIGHT	FEATURES
QR-S003-101	MTB	BLACK	75g/pcs	Fix SHIMANO Ø12mm / 142mm HUB
QR-S003-103	MTB	RED	75g/pcs	Fix SHIMANO Ø12mm / 142mm HUB
QR-E001-001	RACING or MTB	BLACK / SILVER	112g/set~115g/set	O.L.D: (F)100mm (R)130mm or 135mm

SUPER LIGHT CALIPER BRAKE

Single-axis design to reduce the weight of whole brake set.
With ti-64 titanium screws.
Ball bearings in brake pivot.
Alloy 6066 material effectively enhance the overall strength
and improve hard to stress corrosion.

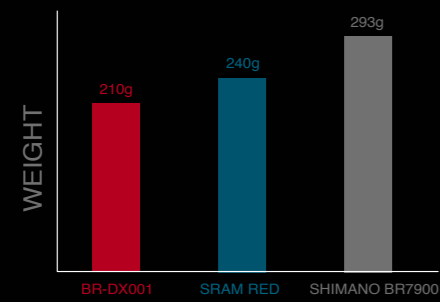

ROAD BRAKE

BR-DX001 Titanium Axle

The use of leverage increases the braking force and the single-axis design to reduce the weight of whole brake set. Alloy 6066 material effectively enhance the overall strength and improve hard to stress corrosion, the weight of whole brake set is being improved to collocate with ti-64 titanium screws. Full CNC manufacturing comes out perfect appearance and good mating of tolerance. Collocate with the swiss stop brake shoes. Approved by CEN test standards.

Product Features:

- Material: Alloy 6066-T6 CNC made
- Brake shoes: CNC cassette
- Bolt: main bolt ti-64
- Dimension: c-c 39-51mm
- Option: swiss stop carbon rim pads available
- Color: polish anodize
- Weight: 210g/set



BR-S003

The use of leverage increases the braking force and the single-axis design to reduce the weight of whole brake set. Alloy 6066 material effectively enhance the overall strength and improve hard to stress corrosion, the weight of whole brake set is being improved to collocate with Cr-Mo screws. Full CNC manufacturing comes out perfect appearance and good mating of tolerance. Approved by CEN test standards.

Product Features:

- Material: Alloy 6066-T6 forged cnc made
- Brake shoes: Forged cassette
- Bolt: main bolt Cr-Mo
- Dimension: c-c 39-51mm
- Option: Ashima carbon rim pads available
- Color: polish anodize
- Weight: 230g/set



MODEL	MODELS	COLOR	WEIGHT	FEATURES
BR-DX001	RACING	BLACK / SILVER RED / GOLD / GRAY	210g/set	REACH: C-C 39~51mm
BR-S003	RACING	BLACK / SILVER RED / GOLD / GRAY	230g/set	REACH: C-C 39~51mm

V-BRAKE

BR-DX002

CNC machined
Unique shape and light weight
Balance spring power adjustable

Product Features:

- Standard v brake design
- Material: Alloy 7075-T6
- Color: Polished black anodize
- Weight: 300g/bike



MODEL	MODELS	COLOR	WEIGHT	FEATURES
BR-DX002-001	MTB	BLACK	300g/set	ALLOY 7075-T6, ARM LENGTH 98mm
BR-DX002-002	MTB	SILVER	300g/set	ALLOY 7075-T6, ARM LENGTH 98mm
BR-DX002-003	MTB	RED	300g/set	ALLOY 7075-T6, ARM LENGTH 98mm
BR-DX002-004	MTB	GOLD	300g/set	ALLOY 7075-T6, ARM LENGTH 98mm
BR-DX002-005	MTB	GRAY	300g/set	ALLOY 7075-T6, ARM LENGTH 98mm

CANTI BRAKE

BR-S001

CNC machined. Unique shape and light weight. Balance spring power adjustable.

Product Features:

- Double plate design canti brake system
- Material: Alloy 6061-T6
- Sandblast finished
- Color: black, silver, red
- With FURIERS logo
- Weight: (F) 102.0g (R) 102.5g



BR-S002

CNC machined. Unique shape and light weight. Balance spring power adjustable.
Ultra 6 cross: Recommended to use in front wheel.
Ultra 7 cross: Recommended to use in rear wheel.

Product Features:

- Double plate design canti brake system
- Material: Alloy 6061-T6
- Sandblast finished
- Color: black, silver, red
- With FURIERS logo
- Weight: (F) 105.0g (R) 105.0g



MODEL	MODELS	COLOR	WEIGHT	FEATURES
BR-S001-101	CYCLO CROSS	BLACK	205g/set	ARM LENGTH (F) 46mm (R) 46mm
BR-S001-102	CYCLO CROSS	SILVER	205g/set	ARM LENGTH (F) 46mm (R) 46mm
BR-S001-103	CYCLO CROSS	RED	205g/set	ARM LENGTH (F) 46mm (R) 46mm
BR-S002-101	CYCLO CROSS	BLACK	210g/set	ARM LENGTH (F) 65mm (R) 76mm
BR-S002-102	CYCLO CROSS	SILVER	210g/set	ARM LENGTH (F) 65mm (R) 76mm
BR-S002-103	CYCLO CROSS	RED	210g/set	ARM LENGTH (F) 65mm (R) 76mm

LEVER

BR-DX003

Full CNC machined. Light weight design V-brake lever. Fit SHIMANO standard brake cable.

Product Features:

- Material: Alloy 6066-T6
- For Ø24 handlebar w/i Ø22.2 shim
- Weight: 70g/pair
- Color: black, red



BR-DX004

Full CNC machined. Light weight design brake lever. For Caliper-brake lever, Canti-brake lever, Mini V-brake lever Fit SHIMANO standard brake cable.

Product Features:

- Material: Alloy 6066-T6
- For Ø24 handlebar w/i Ø22.2 shim
- Weight: 85g/pair
- Color: black, red



MODEL	MODELS	COLOR	WEIGHT	FEATURES
BR-DX003-001	V-BRAKE SYSTEM	BLACK	70g/pair	Fix SHIMANO standard brake cable
BR-DX003-003	V-BRAKE SYSTEM	RED	70g/pair	Fix SHIMANO standard brake cable
BR-DX004-001	CANTI-BRAKE SYSTEM	BLACK	85g/pair	Fix SHIMANO standard brake cable
BR-DX004-003	CANTI-BRAKE SYSTEM	RED	85g/pair	Fix SHIMANO standard brake cable

BRAKE PADS



BR-E001 Titanium Bolt

CNC machined.
Titanium bolt.
Brake pads special for carbon rim.
Angle adjustable with curve washer.

- Product Features:
- Compatible SHIMANO caliper system
 - Material: Alloy 6066-T6



BR-E002

CNC machined.
Stainless steel bolt.
Angle adjustable with curve washer.
+5mm offset to avoid touch fork when release wheel.

- Product Features:
- Compatible double plate canti brake system
 - Material: Alloy 6066-T6



BR-E003

CNC machined.
Stainless steel bolt.
Angle adjustable with curve washer.
-5mm offset to avoid touch frame when release wheel.

- Product Features:
- Compatible double plate canti brake system
 - Material: Alloy 6066-T6



BR-E004

Forged with CNC machined stainless steel bolt.
Angle adjustable with curve washer.

- Product Features:
- Compatible double plate canti brake system
 - Material: Alloy 6061-T6



BR-E005

Forged with CNC machined stainless steel bolt.
Angle adjustable with curve washer.

- Product Features:
- Compatible double plate v brake system
 - Material: Alloy 6061-T6



BR-E006

Forged with CNC made stainless steel bolt brake pads special for alloy rim.
Angle adjustable with curve washer.

- Product Features:
- Compatible SHIMANO caliper system
 - Material: Alloy 6061-T6

MODEL	MODELS	COLOR	WEIGHT	FEATURES
BR-E001-001	ROAD BIKE	BLACK	59g/set	Fix SHIMANO
BR-E001-002	ROAD BIKE	SILVER	59g/set	Fix SHIMANO
BR-E001-003	ROAD BIKE	RED	59g/set	Fix SHIMANO
BR-E002-001	CYCLO CROSS	BLACK	77g/set	Fix CANTI-BRAKE/ Offset +5mm
BR-E002-002	CYCLO CROSS	SILVER	77g/set	Fix CANTI-BRAKE/ Offset +5mm
BR-E002-003	CYCLO CROSS	RED	77g/set	Fix CANTI-BRAKE/ Offset +5mm
BR-E003-001	CYCLO CROSS	BLACK	77g/set	Fix CANTI-BRAKE/ Offset -5mm
BR-E003-002	CYCLO CROSS	SILVER	77g/set	Fix CANTI-BRAKE/ Offset -5mm
BR-E003-003	CYCLO CROSS	RED	77g/set	Fix CANTI-BRAKE/ Offset -5mm

MODEL	MODELS	COLOR	WEIGHT	FEATURES
BR-E004-001	CYCLO CROSS	BLACK	77g/set	Fix CANTI-BRAKE
BR-E004-002	CYCLO CROSS	SILVER	77g/set	Fix CANTI-BRAKE
BR-E004-003	CYCLO CROSS	RED	77g/set	Fix CANTI-BRAKE
BR-E005-001	CYCLO CROSS	BLACK	78g/set	Fix CANTI-BRAKE / BRAKE SHOES Length: 72mm
BR-E005-002	CYCLO CROSS	SILVER	78g/set	Fix CANTI-BRAKE / BRAKE SHOES Length: 72mm
BR-E005-003	CYCLO CROSS	RED	78g/set	Fix CANTI-BRAKE / BRAKE SHOES Length: 72mm
BR-E006-001	ROAD BIKE	BLACK	71g/set	Fix SHIMANO
BR-E006-002	ROAD BIKE	SILVER	71g/set	Fix SHIMANO
BR-E006-003	ROAD BIKE	RED	71g/set	Fix SHIMANO

CHAIN GUIDE

CT-DX005-ISCG CT-DX005-ISCG05

Lightweight chain guide with bash guard /
Bash guard made by strong plastic material from
SWISS.

Product Features:

- Material: Alloy 6061-T6
- BB adapter included (for e type BB mount)
- Range: 32t ~ 38t
- Weight: 210g
- Color: black, red anodize

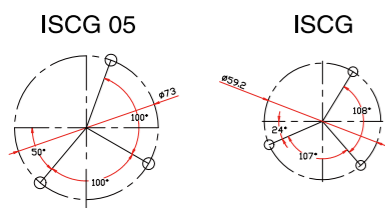

MODEL	MODELS	COLOR	WEIGHT	FEATURES
CT-DX005-001	FREE RIDE / D.H / 4X	BLACK	210g/pcs	For 32t to 38t / ISCG
CT-DX005-003	FREE RIDE / D.H / 4X	RED	210g/pcs	For 32t to 38t / ISCG
CT-DX005-501	FREE RIDE / D.H / 4X	BLACK	210g/pcs	For 32t to 38t / ISCG-05
CT-DX005-503	FREE RIDE / D.H / 4X	RED	210g/pcs	For 32t to 38t / ISCG-05

CT-DX001-ISCG CT-DX001-ISCG05

Lightweight chain guide with full cage so no need for a bash plate.
Aluminium back plate, adjustable strong harden plastic material top
guides and bottom to take chainrings from 40t to 32t / seal bearing
bottom roller make it more smooth / full CNC finished.

Product Features:

- Material: Alloy 6061-T6
- Spec: ISCG or ISCG-05
- BB adapter included (for e type BB mount)
- Size: 32t ~ 40t
- Weight: 162g (without adapter)
- Color: black, red

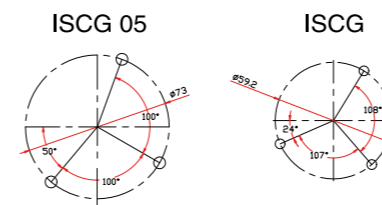

CT-DX002-ISCG CT-DX002-ISCG05

Lightweight chain guide with half cage on upper arm design for bashguard
use. Aluminium back plate, adjustable strong harden plastic material
guides top and bottom to take chainrings from 40t to 32t / sealbearing
bottom roller make it more smooth / full CNC finished.

Product Features:

- Material: Alloy 6061-T6
- Spec: ISCG or ISCG-05
- BB adapter included (for e type BB mount)
- Size: 32t ~ 40t
- Weight: 141.5g (without adapter)
- Color: black, red
- Note: bash plate no include

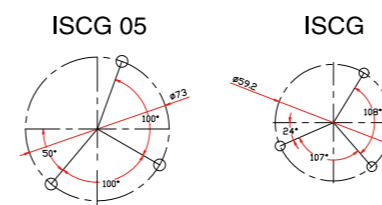

MODEL	MODELS	COLOR	WEIGHT	FEATURES
CT-DX001	FREE RIDE / D.H / 4X	BLACK / RED	162g/pcs	For 32t to 40t / ISCG or ISCG-05
CT-DX002	FREE RIDE / D.H / 4X	BLACK / RED	142g/pcs	For 32t to 40t / ISCG or ISCG-05

CHAIN GUIDE

CT-DX003-ISCG CT-DX003-ISCG05

Strong single lower arm chain guide with CNC cuts in backplate for weight reduction / backplate made of aluminium. Roller with sealed bearing / together with bashguard may used for double chainring drive. BB adapter included / adjustable silent step roller.

Product Features:

- Material: Alloy 6061-T6
- Spec: ISCG or ISCG-05
- BB adapter included (for e type BB mount)
- Thickness: 4mm
- Size: 32t ~ 40t
- Weight: 95g (with out adapter)
- Color: black, red



CT-DX004

Chain guide design for MTB 1x9 or 1x10 Drive train. Light weight design, easy for adjustment from 32t to 40t includes spacers for fine chainline. Adjustability only fit for BB e-type Mount version. Super strong plastic chain guide on the top.

Product Features:

- Material: Alloy 6061-T6
- Teeth: 32t ~ 40t
- Weight: 80g
- Color: black, red



AC-S003

To use this chain catcher, can protect the BB on your bike, and the chain is not easy to fall down when you shift the front chainwheel on high speed riding.

Product Features:

- Material: Alloy 6061-T6 Carbon coating
- Range: 39t ~ 53t, 34t ~ 50t
- Color: Carbon 3K
- Weight: 7.5g (without bolt)
- Color: black, silver, red, gold, gray



MODEL	MODELS	COLOR	WEIGHT	FEATURES
CT-DX003	MTB / FREE RIDE / D.H / 4X	BLACK / RED	95g/pcs	For 32t to 40t / ISCG or ISCG-05
CT-DX004	MTB / FREE RIDE / D.H / 4X	BLACK / RED	80g/pcs	For 32t to 40t / For BB e-type
AC-S003-100	RACING	Carbon 3K	7.3g/pcs	Fix 39t ~ 53t or 34t ~ 50t

BASH GUARD

CG-DX001

Designed to protect your middle and inner chainring from impacts super thick, heat treated aluminium CNC made / CNC cut hole to let the mud get away.

Product Features:

- Material: Alloy 6061-T6 CNC made
- P.C.D: 104mm
- Size: 36t (OD: 160mm)
38t ~ 40t (OD: 180mm)
- Thickness: 4mm
- Weight: 84.5g (36t~37t)
- Color: black, red, gray



CG-S001

Lightweight bash-guard with no holes . Polycarbonate with brass copper bushing construction / CNC made finished.

Product Features:

- Material: Poly carbonate CNC made
- P.C.D: 104mm
- Size: 36t (OD: 160mm)
38t ~ 40t (OD: 180mm)
- Thickness: 10mm
- Weight: 113g (36t~37t)



MODEL	MODELS	COLOR	WEIGHT	FEATURES
CG-DX001	MTB / FREE RIDE / D.H / 4X	BLACK / RED GRAY	85g~90g	For 36t (OD Ø160mm) or 38t ~ 40t (OD Ø180mm)
CG-S001	FREE RIDE / D.H / 4X	CLEAR	113g~170g	For 36t (OD Ø160mm) or 38t ~ 40t (OD Ø180mm)

TRI-BAR

Spring loaded aluminum arm pads that swing up out of the way where you aren't using them. Very convenient for maintaining all your varied hand positions. With 300mm extensions, length can be cut short.

Product Features:

- Triathlon armrest
- Material: Alloy 6061-T6
- For Ø31.8 handlebar

HB-TR001-101

With S tube / Angle 17°
300mm



HB-TR001-201

With J1 tube / Angle 17°
300mm



HB-TR001-301

With J2 tube / Angle 50°
300mm



Armrest can be automatic swing up



MODEL	MODELS	COLOR	WEIGHT	FEATURES
HB-TR001-101	RACING / TRIATHLON	BLACK	491.0g	Fix Ø31.8 Bar-bore With S tubes
HB-TR001-201	RACING / TRIATHLON	BLACK	491.0g	Fix Ø31.8 Bar-bore With J1 tubes
HB-TR001-301	RACING / TRIATHLON	BLACK	491.0g	Fix Ø31.8 Bar-bore With J2 tubes

ACCESSORIES



HB-TR002

Triathlon extension bars bridge.
5mm pitch adjustable width. Maximum 20mm.
With Ø26.0 computer tube.

Product Features:

- For Triathlon bar bridge
- Material: Nylon
- Width: 85mm-105mm
- Weight: 54g/set

WBC-DX001

For Triathlon bar water bottle cage adapter.
Simple and fixed in Triathlon bar can fix any water bottle.

Product Features:

- Clamping the water bottle cage
- For Triathlon bar
- Material: Alloy 6061-T6
- Color: Sandblast black anodize
- Weight: 30g/pcs

MODEL	MODELS	COLOR	WEIGHT	FEATURES
HB-TR002-100	RACING / TRIATHLON	BLACK	54g/set	TRIATHLON BAR BRIDGE
WBC-DX001	RACING / TRIATHLON	S.B BLACK / S.B SILVER	30g/set	WATER BOTTLE CAGE ADAPTER

ACCESSORIES



HA-S001 CARBON

Canti Brake cable hanger.
Carbon spacer can reduce brake noise.

Product Features:

- Material: Carbon 3K
- For Ø28.6 fork tube
- Height: 4mm
- Weight: 29g/set



HA-S002 CARBON

CNC Machined
Ultra light alloy special double clamp.

Product Features:

- Material: Alloy 6061-T6
- For Ø31.8 handlebar
- Ø26 Carbon tube for computer mount
- With FOURIERS logo
- Weight: 32g/pcs



WBC-S001 CARBON

Specially designed AERO water bottle cage.
More in line with the competition! L size can hold 600cc of water and easier to extract! S size can hold 300cc energy drinks!

Product Features:

- Material: Carbon UD cage+ Plastic water bottle
- Volume: (L) 600cc, (S) 300cc
- Weight: (L) 82.5g, (S) 62.5g, (CAGE) 26g



WBC-S002-100

WBC-S002 CARBON

Easy to take water bottle / Carbon construction
for a perfect fusion of strength and light weight.

Product Features:

- Material: Carbon 3K
- Weight: 34g/pcs



WBC-S002-200



WBC-S002-300

MODEL	MODELS	COLOR	WEIGHT	FEATURES
HA-S001-100	CYCLO CROSS	3K	29g/pcs	Fix 1-1/8" Fork
HA-S002-001	All models	3K	29g/pcs	Handlebar clamp Ø31.8 & computer mount Ø26

MODEL	MODELS	COLOR	WEIGHT	FEATURES
WBC-S001-100	All models	CARBON 3K	175g/set	WATER BOTTLE & CAGE
WBC-S002-100	All models	CARBON 3K	34g/pcs	WATER BOTTLE & CAGE
WBC-S002-200	All models	CARBON 3K	34g/pcs	WATER BOTTLE & CAGE
WBC-S002-300	All models	CARBON 3K	34g/pcs	WATER BOTTLE & CAGE

TOP CAP

TC-DX001

New light weight color Top Caps is a great way to update your bike / Make of alloy full CNC cut, smooth sureface high quality finish.

Product Features:

- Material: Alloy 6061-T6
- Spec: Fit on 1-1/8 fork
- Color: black, silver, red, gold, gray, blue, apple green, orange, purple, green
- With FOURIERS logo
- Weight: 9.3g (without star nut)



TC-DX002

New light weight color Top Caps is a great way to update your bike / Make of alloy full CNC cut, smooth sureface high quality finish.

Product Features:

- Material: Alloy 6061-T6
- Spec: Fit on 1-1/8 fork
- Color: black, silver, red, gold, gray, blue, apple green, orange, purple, green
- With FOURIERS logo
- Weight: 9.8g (without star nut)



TC-S003 Titanium

Superlight Titanium top cap, CNC machined, also with M6 Titanium bolt.

Product Features:

- Material: Ti-64
- Spec: Fit on 1-1/8 fork
- With Titanium bolt
- With FOURIERS logo
- Weight: 9.5g (without star nut)



TC-S001

Special stem top cap design to combine with any beer bottle cap you can buy in the market. it is a super cool design to have your favorite beer mark on your bike / Simple to clip on.

Product Features:

- Material: Alloy 6061-T6 CNC finished.
- Spec: Fit on 1-1/8 fork
- With FOURIERS logo
- Weight: 23g (without star nut)
- Color: black, silver



TC-S002-UD CARBON TC-S002-3K

Make of full carbon light weight design stem top cap, with stainless main bolt the only chose to make your bike look like pro.

Product Features:

- Material: 100% Carbon with stainless bolt
- Spec: Fit on 1-1/8 fork
- Finish: 3K or UD
- with Stainless bolt
- Weight: 14g (without star nut)



TC-E001

Economic top cap / classic design.

Product Features:

- Material: Alloy 6061-T6
- Spec: Fit on 1-1/8 fork
- Color: black, silver, red, gold, gray, blue, apple green, orange, purple, green
- With FOURIERS logo
- Weight: 14.5g (without star nut)



MODEL	MODELS	COLOR	WEIGHT	FEATURES
TC-DX001	All models	BLACK / SILVER / RED / GOLD / GRAY / BLUE APPLE GREEN / ORANGE VIOLET / GREEN	9.3g/pcs	FIX 1-1/8" FORK / With stainless bolt
TC-DX002	All models	BLACK / SILVER / RED GOLD / GRAY / BLUE APPLE GREEN / ORANGE VIOLET / GREEN	9.8g/pcs	FIX 1-1/8" FORK / With stainless bolt
TC-S003-500	All models	TITANIUM	9.5g/pcs	FIX 1-1/8" FORK / With Titanium bolt

MODEL	MODELS	COLOR	WEIGHT	FEATURES
TC-S001	All models	BLACK / SILVER	23g/pcs	FIX 1-1/8" FORK / With stainless bolt
TC-S002	All models	CARBON 3K / UD	14g/pcs	FIX 1-1/8" FORK / With stainless bolt
TC-E001	All models	BLACK / SILVER / RED GOLD / GRAY / BLUE APPLE GREEN / ORANGE VIOLET / GREEN	14.5g/pcs	FIX 1-1/8" FORK / With stainless bolt

HEAD ACCESSORIES



HA-S004
For Giant OD2 System

For Ø31.8 alloy or Cr-Mo fork only
With alloy lightweight top cap.

Product Features:

- Material: Heat treatment star nut with alloy top cap.
- For ID Ø28.8 Fork
- Top Cap Color: black, silver, red, gold, gray
- Weight: 23.5g/set



HA-S008

Integrated headset system.
Angle contact seal bearing.

Product Features:

- Material: Top cover Alloy 6061-T6
- Spec: Integrated 1-1/8" Upper / 1.5" Bottom
(UP) Ø28.6 x Ø41.8 / (DOWN) Ø51.8 x Ø39.5
- Bearing: (UPPER) 41.8 x 45° x 8 (LOWER) 51.8 x 45° x 8
- Weight: 78g/set

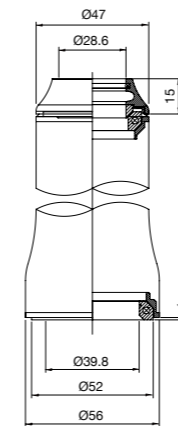

HA-S006

For Ø28.6 alloy or Cr-Mo fork only
With alloy lightweight top cap.

Product Features:

- Material: Heat treatment star nut with alloy top cap.
- For ID Ø25.4 Fork
- Top Cap Color: black, silver, red, gold, gray
- Weight: 24.5g/set



HA-S009

Integrated headset system.
Angle contact seal bearing.
Strong and smooth.

Product Features:

- Material: Top cover Alloy 6061-T6
- Spec: Integrated 1-1/8" Upper / 1-1/8" Bottom
(UP) Ø28.6 x Ø41.8 / (DOWN) Ø28.6 x Ø41.8
- Bearing: Ø41.8 x 45° x 8
- Weight: 85g/set

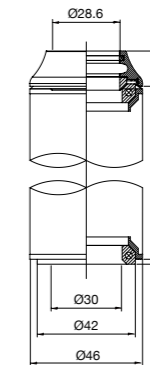

HA-S003
For Giant OD2 System

For Ø31.8 carbon fork inner tube expander.
Protect carbon fork tube when over tighten.
With alloy lightweight top cap.

Product Features:

- Material: Alloy 6061-T6 with Alloy top cap.
- For ID Ø27.5 ~ Ø27.7 Fork
- Length: 45mm
- Top Cap Color: black, silver, red, gold, gray
- Weight: 56g/set



HA-S005

For Ø28.6 carbon fork inner tube expander.
Protect carbon fork tube when over tighten.
With alloy lightweight top cap.

Product Features:

- Material: Alloy 6061-T6 with Alloy top cap.
- For ID Ø22.0 ~ Ø25.0 Fork
- Length: 50mm
- Top Cap Color: black, silver, red, gold, gray
- Weight: 62g/set



MODEL	MODELS	COLOR	WEIGHT	FEATURES
HA-S003	Ø31.8 CARBON FORK	BLACK / SILVER RED / GOLD / GRAY	56g/set	FIX 1-1/4" FORK
HA-S005	Ø28.6 CARBON FORK	BLACK / SILVER RED / GOLD / GRAY	62g/set	FIX 1-1/8" FORK

MODEL	MODELS	COLOR	WEIGHT	FEATURES
HA-S004	FOR ALLOY or CR-MO STEEL FORK	BLACK / SILVER RED / GOLD / GRAY	23.5g/set	FIX 1-1/4" FORK / With Star nut
HA-S006	FOR ALLOY or CR-MO STEEL FORK	BLACK / SILVER RED / GOLD / GRAY	24.5g/set	FIX 1-1/8" FORK / With Star nut
HA-S008	RACING	S.B BLACK	78g/set	INTEGRATED: 1-1/8" upper / 1.5" bottom
HA-S009	RACING	S.B BLACK	85g/set	INTEGRATED: 1-1/8" upper / 1-1/8" bottom

SPACER



SR-S003

Transparent classic Nylon spacer, Anti solvent unique raw material from swiss (E.M.S). Different from the PC material the nylon stay more solvent resistance and can be load for good performance. variety of colors to choice.

Product Features:

- Diameter ID: Ø28.6 OD:Ø36
- Set of 3 spacers: 5mm x 2pcs, 10mm x 1pcs.
- Material: Transparent NYLON
- Weight: 7.2g/set.
- Color: white, blue, orange, light orange, light green, green, clear, light pink, violet, black

MODEL	MODELS	COLOR	WEIGHT	FEATURES
SR-S003-001	All models	BLACK	7.2g/set	FIX 1-1/8" FORK / 10mm x 1 + 5mm x 2
SR-S003-006	All models	BLUE	7.2g/set	FIX 1-1/8" FORK / 10mm x 1 + 5mm x 2
SR-S003-007	All models	LIGHT GREEN	7.2g/set	FIX 1-1/8" FORK / 10mm x 1 + 5mm x 2
SR-S003-008	All models	ORANGE	7.2g/set	FIX 1-1/8" FORK / 10mm x 1 + 5mm x 2
SR-S003-009	All models	VIOLET	7.2g/set	FIX 1-1/8" FORK / 10mm x 1 + 5mm x 2
SR-S003-010	All models	GREEN	7.2g/set	FIX 1-1/8" FORK / 10mm x 1 + 5mm x 2
SR-S003-011	All models	LIGHT PINK	7.2g/set	FIX 1-1/8" FORK / 10mm x 1 + 5mm x 2
SR-S003-012	All models	WHITE	7.2g/set	FIX 1-1/8" FORK / 10mm x 1 + 5mm x 2
SR-S003-013	All models	CLEAR	7.2g/set	FIX 1-1/8" FORK / 10mm x 1 + 5mm x 2
SR-S003-014	All models	LIGHT ORANGE	7.2g/set	FIX 1-1/8" FORK / 10mm x 1 + 5mm x 2



SR-S001 CARBON

Classic carbon spacer.

Product Features:

- Diameter ID: Ø28.6 OD: Ø34
- Set of 4 spacers: 3, 5, 10mm, Taper Spacer
- Material: Carbon 3K / Alloy 6061-T6
- Weight: 10.5g/set



SR-S002 CARBON

Ultra-lightweight carbon spacers. Unique design saves up to 38% on weight.

Product Features:

- Diameter ID: Ø28.6 OD: Ø34
- Set of 4 spacers: 3mm, 5mm, 10mm, Taper Spacer
- Material: Carbon 3K / Alloy 6061-T6
- Weight: 8.3g/set



SR-E001

Classic aluminum spacer. High Polishing Anodized finish.

Product Features:

- Diameter ID: Ø28.6 OD: Ø34
- Set of 4 spacers: 3mm, 5mm, 10mm, Taper Spacer
- Material: Alloy 6061-T6
- Weight: 15.5g/set



SR-E002

Ultra-lightweight Aluminium spacers. Unique design saves up to 38% on weight.

Product Features:

- Diameter ID: Ø28.6 OD: Ø34
- Set of 4 spacers: 3mm, 5mm, 10mm, Taper Spacer
- Material: Alloy 6061-T6
- Weight: 10.5g/set

MODEL	MODELS	COLOR	WEIGHT	FEATURES
SR-S001-100	All models	3K	10.5g/set	FIX 1-1/8" FORK
SR-S002-100	All models	3K	8.3g/set	FIX 1-1/8" FORK
SR-E001-001	All models	BLACK	15.5g/set	FIX 1-1/8" FORK
SR-E001-002	All models	SILVER	15.5g/set	FIX 1-1/8" FORK
SR-E002-001	All models	BLACK	10.5g/set	FIX 1-1/8" FORK
SR-E002-002	All models	SILVER	10.5g/set	FIX 1-1/8" FORK

CHAIN RING



CR-DX001

High strength aluminum material to get more efficient power, archaic model to bring your bike with more features.

Product Features:

- 5 arm for single speed
- Material: Alloy 7075-T651 full CNC made
- P.C.D: Ø130, Ø144
- **Teeth: 44 ~ 53**
- Thickness: 3mm
- Color: black, silver anodize



CR-DX002

High strength aluminum material to get more efficient power, archaic model to bring your bike with more features.

Product Features:

- 5 arm for single speed
- Material: Alloy 7075-T651 full CNC made
- P.C.D: Ø130, Ø144
- **Teeth: 44 ~ 53**
- Thickness: 3mm
- Color: black, silver anodize

MODEL	MODELS	COLOR	WEIGHT	FEATURES
CR-DX001	TRACK	BLACK / SILVER		Teeth: 44T~53T / Thickness: 3mm / P.C.D: 130mm or 144mm / 5 arm for single speed
CR-DX002	TRACK	BLACK / SILVER		Teeth: 44T~53T / Thickness: 3mm / P.C.D: 130mm or 144mm / 5 arm for single speed

COG

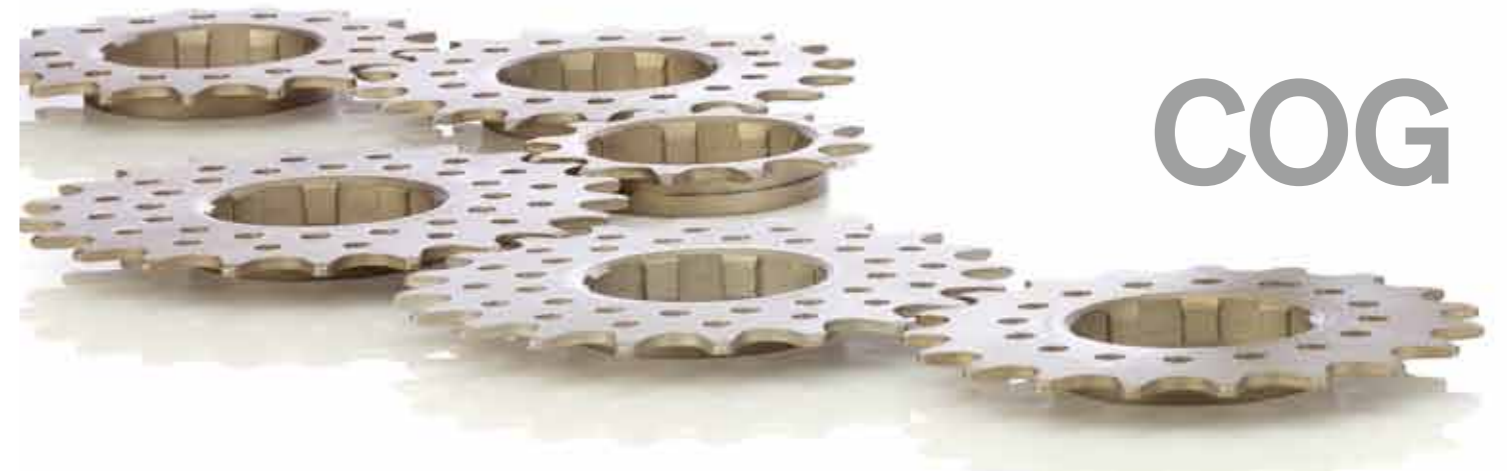

CR-S001

Design for cassette HUB to convert your bike into a single speed HUB. Cog is made by **harden cold forged Cr-Mo steel (ASM4140)** to make it super strong and long life use / Very tight tolerances before under going heat treatment from size 12t, 16t~23t to fix most of the rider requirement.

Product Features:

- For cassette HUB
- Material: Cold forged Cr-Mo heat treated steel (ASM4140) N.E.N finished
- With lock ring x 1pcs & 10mm x1, 5mm x2, 3mm x3 Spacer
- Teeth: 12t, 16t ~ 23t



MODEL	MODELS	COLOR	WEIGHT	FEATURES
CR-S001-120	CASSETTE HUB	ELECTROLESS NICKEL		12t COG+Spacer 10mmx1+5mmx2+3mmx3+Lockring
CR-S001-160	CASSETTE HUB	ELECTROLESS NICKEL		16t COG+Spacer 10mmx1+5mmx2+3mmx3+Lockring
CR-S001-170	CASSETTE HUB	ELECTROLESS NICKEL		17t COG+Spacer 10mmx1+5mmx2+3mmx3+Lockring
CR-S001-180	CASSETTE HUB	ELECTROLESS NICKEL		18t COG+Spacer 10mmx1+5mmx2+3mmx4+Lockring
CR-S001-190	CASSETTE HUB	ELECTROLESS NICKEL		19t COG+Spacer 10mmx1+5mmx2+3mmx4+Lockring
CR-S001-200	CASSETTE HUB	ELECTROLESS NICKEL		20t COG+Spacer 10mmx1+5mmx2+3mmx5+Lockring
CR-S001-210	CASSETTE HUB	ELECTROLESS NICKEL		21t COG+Spacer 10mmx1+5mmx2+3mmx5+Lockring
CR-S001-220	CASSETTE HUB	ELECTROLESS NICKEL		22t COG+Spacer 10mmx1+5mmx2+3mmx6+Lockring
CR-S001-230	CASSETTE HUB	ELECTROLESS NICKEL		23t COG+Spacer 10mmx1+5mmx2+3mmx6+Lockring

COG



CR-S002

Design for mounts onto 6 bolt disc-HUB to convert your bike into a fixed wheel and with special adapter to fixed on SHIMANO cassette HUB to change to single speed / Adapter is made of light weight Alloy 6061-T6 disc, cog is made by **harden cold forged Cr-Mo steel (ASM4140)** to make it super strong and long life use / Very tight tolerances before undergoing heat treatment also with 6 stainless bolt.

Product Features:

- Material: cold forged Cr-Mo heat treated steel (ASM4140) and Alloy 6060-T6 for the adapter
- Teeth: 16t ~ 23t
- Color: N.E.N finished cog / red anodize adapter
- Use for disc HUB 6 hole and cassette HUB
- With lock ring x 1pcs & 10mm x1, 5mm x2, 3mm x3 Spacer



CR-S003

Design for mounts into 6 bolt disc-HUB to convert your bike into a fixed wheel. Cog is made by **harden cold forged Cr-Mo steel (ASM4140)** to make it super strong and long life use / Very tight tolerances before undergoing heat treatment also with 6 stainless bolt.

Product Features:

- Material: cold forged Cr-Mo heat treated steel (ASM4140)
- Teeth: 16t ~ 23t
- Color: N.E.N finished for cog
- Use for disc HUB 6 hole



CR-S004-1.8 CR-S004-3

Design for mounts on single fixed bike HUB. Super strong material from **cold forged Cr-Mo steel (ASM4140)** with heat treated. We also have 5 ED color for you to choose and a special washer to put on your HUB before you install the cog this is to protect your HUB because the alloy HUB is too soft when the cog is super strong.

Product Features:

- Material: cold forged Cr-Mo heat treated steel.
- For chain: 3/32 (1.8mm) and 1/8 (3mm)
- Teeth: 12t~23t
- Color: ELECTROLESS NICKEL, ED blue, ED orange, ED purple, ED green, ED pink
- With lock ring

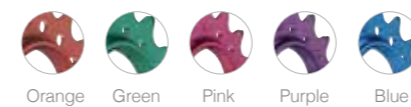

MODEL	MODELS	COLOR	WEIGHT	FEATURES
CR-S004	FIX GEAR HUB	ELECTROLESS NICKEL ED PINK / ED BLUE ED/ORANGE / ED VIOLET ED GREEN	49g/set~133g/set	Teeth Thickness: 3/32" or 1/8" - 12t~23t COG + Lockring

MODEL	MODELS	COLOR	WEIGHT	FEATURES
CR-S002	CASSETTE HUB	ELECTROLESS NICKEL	56g~103g	16t~23t COG + RED alloy adapter + 6pcs bolt
CR-S003	DISC 6 HOLE	ELECTROLESS NICKEL	35g/set~82g/set	16t~23t COG + 6pcs bolt

ACCESSORIES



AC-S002 CARBON

Adapter for stem bar bore Ø35mm change to Ø31.8mm.
Through the carbon fiber material properties, can reduce the vibration when riding.

Product Features:

- Material: Carbon UD
- Spec: OD Ø35mm to ID Ø31.8mm or
OD Ø31.8mm to ID Ø26mm or
OD Ø31.8mm to ID Ø25.4mm
- Width: 60mm

AC-S001 CARBON

Adapter for stem fork tube Ø31.8mm change to Ø28.6mm.

Product Features:

- Stem fork tube adapter
- Material: Carbon UD
- Spec: OD Ø31.8mm to ID Ø28.6mm
- Length: 38mm, 48mm, 58mm



MODEL	MODELS	COLOR	WEIGHT	FEATURES
AC-S002-100	All models	UD	14.0g/pcs~24.0g/set	Ø35mm x Ø31.8mm or Ø31.8mm x Ø26mm or Ø31.8mm x Ø25.4mm / Width 60mm
AC-S001	All models	UD	10.0g~15.5g	ID: Ø31.8mm x ID: Ø28.6mm / Length: 38mm or 48mm or 58mm



AC-DX001

Full cnc lightweight pulley / Special design to prevent dust and water get into bearing / It's the best choice to make your bike more light on riding.

Product Features:

- Material: Alloy 7075-T651 body, Alloy 6061-T6 cap
- Bearing: CR-steel seal bearing
- Teeth: 11T
- Weight: 21g/set
- Color: black, silver, red, gold, gray

MODEL	MODELS	COLOR	WEIGHT	FEATURES
AC-DX001-001	RACING / MTB	BLACK	21g/set	Fix SHIMANO 8-,9-,10- speed / CAMPAGNOLO 9-,10- speed
AC-DX001-002	RACING / MTB	SILVER	21g/set	Fix SHIMANO 8-,9-,10- speed / CAMPAGNOLO 9-,10- speed
AC-DX001-003	RACING / MTB	RED	21g/set	Fix SHIMANO 8-,9-,10- speed / CAMPAGNOLO 9-,10- speed
AC-DX001-004	RACING / MTB	GOLD	21g/set	Fix SHIMANO 8-,9-,10- speed / CAMPAGNOLO 9-,10- speed
AC-DX001-005	RACING / MTB	GRAY	21g/set	Fix SHIMANO 8-,9-,10- speed / CAMPAGNOLO 9-,10- speed
AC-S004-001	MTB	S.B BLACK	41g/set	For CENTER LOCK DISC HUB
AC-S004-002	MTB	S.B SILVER	41g/set	For CENTER LOCK DISC HUB



AC-S004

SHIMANO center-lock disc hub adapter.

Product Features:

- SHIMANO center-lock disc hub adapter.
- Material: Alloy 6061-T6 body and lock ring /
Stainless steel washer.
- Weight: 41g/set
- Body color: Sandblast black, Sandblast silver

BOLT

BN-M001

Full CNC chainring bolt.



- Product Features:
- Chainring bolt.
 - Material: Alloy 7075-T6 full CNC made anodized finish
 - Spec: M8 x 0.75
 - Width: 7mm
 - Tool: 5mm or Trox30
 - Weight: 2.0g/pair (7mm)
 - Color: black, silver, red, gold, gray, blue, apple green, orange, violet, green
 - 1 sets = 5 pair

BN-M002

Special shape of the screw, which can cover the bottle cage hole on the frame.



- Product Features:
- Water bottle cage bolt.
 - Material: Alloy 7075-T6 full CNC made anodized finish
 - Spec: M5 x 0.8
 - Length: 10mm
 - Weight: 1.3g/pcs
 - Color: black, silver, red, gold, gray, blue, apple green, orange, violet, green

BN-M003

Special alloy bolt full CNC machined.



- Product Features:
- Water bottle cage bolt.
 - Material: Alloy 7075-T6 full CNC made anodized finish
 - Spec: M5 x 0.8
 - Length: 17mm
 - Weight: 1.3g/pcs
 - Color: black, silver, red, gold, gray, blue, apple green, orange, violet, green

BN-TA001 Titanium

Highest quality Titanium Hex Bolts / It's the best choice to make your bike more light on riding.



- Product Features:
- Material: Titanium 64
 - Spec: M5 x 0.8
 - Length: 15mm
 - Tool Hole: 4mm Allen key
 - 1 set = 2 pcs
 - Weight: 4.5g/set

BN-TA002 Titanium

Highest quality Titanium Hex Bolts / It's the best choice to make your bike more light on riding.



- Product Features:
- Material: Titanium 64
 - Spec: M5 x 0.8
 - Length: 18mm
 - Tool Hole: 4mm Allen key
 - 1 set = 2 pcs
 - Weight: 5.0g/set

BN-TA003 Titanium

Water bottle cage. Highest quality Titanium Hex Bolts / It's the best choice to make your bike more light on riding.



- Product Features:
- Material: Titanium 64
 - Spec: M5 x 0.8
 - Length: 12mm
 - Tool Hole: 4mm Allen key
 - 1 set = 2 pcs
 - Weight: 4.0g/set

MODEL	MODELS	COLOR	WEIGHT	FEATURES
BN-M001	All models	BLACK / SILVER / RED GOLD / GRAY / BLUE APPLE GREEN / ORANGE VIOLET / GREEN	10g/set	M8x0.75 / Length 7mm / Tool hole: 5mm Allen key or Trox 30 / 1set = 5pair
BN-M002	All models	BLACK / SILVER / RED GOLD / GRAY / BLUE APPLE GREEN / ORANGE VIOLET / GREEN	2.6g/set	M5x0.8 / Length: 10mm / 4mm Allen key / 1set = 2pcs
BN-M003	All models	BLACK / SILVER / RED GOLD / GRAY / BLUE APPLE GREEN / ORANGE VIOLET / GREEN	2.6g/set	M5x0.8 / Length: 10mm / 4mm Allen key / 1set = 2pcs

MODEL	MODELS	COLOR	WEIGHT	FEATURES
BN-TA001	All models	TITANIUM	4.5g/set	M5x0.8 / Length: 15mm / 4mm Allen key / 1set = 2pcs
BN-TA002	All models	TITANIUM	5.0g/set	M5x0.8 / Length: 18mm / 4mm Allen key / 1set = 2pcs
BN-TA003	All models	TITANIUM	4.0g/set	M5x0.8 / Length: 12mm / 4mm Allen key / 1set = 2pcs

VALVE EXTENDER

VALVE CAP



VL-PE001

Lightweight alloy valve extenders.

Product Features:

- Presta valve extender CNC Machined
- Anodize finished
- Material: Alloy 6061-T6
- With FOURIERS logo
- Spec: 25, 38, 50, 60, 70, 80, 90, 100(mm)
- Color available: black, silver



VL-PE002

Lightweight alloy valve extenders, with tool.

Product Features:

- Presta valve extender CNC Machined
- Anodize finished
- Material: Alloy 6061-T6
- With FOURIERS logo
- Spec: 20, 30, 40, 50, 60, 70, 80, 90, 100(mm)
- Color available: black, silver



VL-PE003

Lightweight alloy valve extenders, With tool,
Only for Vittoria tubular tire.

Product Features:

- Presta valve extender CNC Machined
- Only for Vittoria tubular tire
- Anodize finished
- Material: Alloy 6061-T6
- Spec: 30, 40, 50, 60, 70(mm)
- Color available: black, silver



VL-PE004

Lightweight alloy valve cap.

Product Features:

- Presta valve cap CNC Machined
- Material: Alloy 6061-T6, Anodize finished
- With a diamond
- Color: black, silver, red, gold, gray, blue, apple green, orange



VL-PE005

Disc wheel 90 degree adapter.
Special design to be match convenient when pumping on disc wheel.

Product Features:

- Disc wheel 90 degree adapter
- Fix Presta valve rim
- Material: Alloy 6061-T6 CNC made
- Weight: 9.6g
- Color: black



VL-PE006

Special design and lightweight to dress up the wheels on your vehicle. With both USA & Presta valve / It's the best choice to make your bike more light on riding.

Product Features:

- Material: Alloy 6061-T6 CNC made
- Spec: Both USA & Presta valve
- 1 set = 2pcs
- Weight: 7.0g/set
- Color: black, silver, red, gold, gray, blue, apple green, orange

MODEL	MODELS	COLOR	WEIGHT	FEATURES
VL-PE001	Presta inner tube	BLACK SILVER	2.2g/set~16g/set	Length: 25mm, 38mm, 50mm, 60mm, 70mm, 80mm, 90mm, 100mm / 1set = 2pcs
VL-PE002-201	Presta inner tube	BLACK SILVER	2.2g/set~12g/set	Length: 20mm, 30mm, 40mm, 50mm, 60mm, 70mm, 80mm, 90mm, 100mm / 1set = 2pcs + Tool x 1pcs
VL-PE003-301	Vittoria inner tube	BLACK SILVER	4.2g/set~10.2g/set	Length: 30mm, 40mm, 50mm, 60mm, 70mm / 1set = 2pcs + Tool x 1pcs

MODEL	MODELS	COLOR	WEIGHT	FEATURES
VL-PE004	Presta inner tube	BLACK / SILVER / RED GOLD / GRAY / BLUE APPLE GREEN / ORANGE	2.9g/set	Presta 12# x 24 / 1set = 2pcs
VL-PE005	DISC inner tube	BLACK	9.6g/pcs	For Presta valve
VL-PE006	Presta inner tube	BLACK / SILVER / RED GOLD / GRAY / BLUE APPLE GREEN / ORANGE	7.0g/set	Presta 12# x 24 / 1set = 2pcs

VALVE CAP

TOOL

VL-US003



Special design valve adapter, lightweight, switch presta to schrader valve.

- Product Features:
- Material: Alloy 6061-T6 CNC made
 - Spec: Presta change to USA valve
 - 1 set = 2pcs
 - Weight: 2.3g/set
 - Color: black, silver, red, gold, gray.

VL-US001



Great and inexpensive way to dress up the wheels on your bike.

- Product Features:
- Material: Alloy 6061-T6 CNC made
 - Spec: USA valve
 - 1 set = 2pcs
 - Weight: 13.0g/set
 - Color: black, silver, red, gold, gray.

VL-US002



Great and inexpensive way to dress up the wheels on your bike.

- Product Features:
- Material: Alloy 6061-T6 CNC made
 - Spec: USA valve
 - 1 set = 2pcs
 - Weight: 18.7g/set
 - Color: black, silver, red, gold, gray

MODEL	MODELS	COLOR	WEIGHT	FEATURES
VL-US003	USA inner tube	BLACK / SILVER / RED GOLD / GRAY	2.3g/set	Presta change to USA valve
VL-US001-001	USA inner tube	BLACK / SILVER / RED GOLD / GRAY	13.0g/set	For USA valve
VL-US002-001	USA inner tube	BLACK / SILVER / RED GOLD / GRAY	18.7g/set	For USA valve

TL-S001

Heat treated for long life / Five colors to choose.



- Product Features:
- Material: Heat treatment steel 6150 tool / Nylon body
 - Spec: 4mm, 5mm, 6mm
 - Length: 65mm, 80mm
 - Color: Body- blue, red, black, apple green, gray
Ring- yellow 6mm, orange 5mm, purple 4mm
 - End shape: Ball or Hex wrench









MODEL	MODELS	COLOR	WEIGHT	FEATURES
TL-S001-651	HEX WRENCH	BLACK	62.5g/pcs	4mm , 5mm , 6mm Allen key / Length: 65mm / Hex wrench
TL-S001-653	HEX WRENCH	RED	62.5g/pcs	4mm , 5mm , 6mm Allen key / Length: 65mm / Hex wrench
TL-S001-655	HEX WRENCH	GRAY	62.5g/pcs	4mm , 5mm , 6mm Allen key / Length: 65mm / Hex wrench
TL-S001-656	HEX WRENCH	BLUE	62.5g/pcs	4mm , 5mm , 6mm Allen key / Length: 65mm / Hex wrench
TL-S001-657	HEX WRENCH	APPLE GREEN	62.5g/pcs	4mm , 5mm , 6mm Allen key / Length: 65mm / Hex wrench
TL-S001-6511	HEX WRENCH	BLACK	62.0g/pcs	4mm , 5mm , 6mm Allen key / Length: 65mm / Balldriver
TL-S001-6513	HEX WRENCH	RED	62.0g/pcs	4mm , 5mm , 6mm Allen key / Length: 65mm / Balldriver
TL-S001-6515	HEX WRENCH	GRAY	62.0g/pcs	4mm , 5mm , 6mm Allen key / Length: 65mm / Balldriver
TL-S001-6516	HEX WRENCH	BLUE	62.0g/pcs	4mm , 5mm , 6mm Allen key / Length: 65mm / Balldriver
TL-S001-6517	HEX WRENCH	APPLE GREEN	62.0g/pcs	4mm , 5mm , 6mm Allen key / Length: 65mm / Balldriver
TL-S001-801	HEX WRENCH	BLACK	69.5g/pcs	4mm , 5mm , 6mm Allen key / Length: 80mm / Hex wrench
TL-S001-803	HEX WRENCH	RED	69.5g/pcs	4mm , 5mm , 6mm Allen key / Length: 80mm / Hex wrench
TL-S001-805	HEX WRENCH	GRAY	69.5g/pcs	4mm , 5mm , 6mm Allen key / Length: 80mm / Hex wrench
TL-S001-806	HEX WRENCH	BLUE	69.5g/pcs	4mm , 5mm , 6mm Allen key / Length: 80mm / Hex wrench
TL-S001-807	HEX WRENCH	APPLE GREEN	69.5g/pcs	4mm , 5mm , 6mm Allen key / Length: 80mm / Hex wrench
TL-S001-8011	HEX WRENCH	BLACK	69.0g/pcs	4mm , 5mm , 6mm Allen key / Length: 80mm / Balldriver
TL-S001-8013	HEX WRENCH	RED	69.0g/pcs	4mm , 5mm , 6mm Allen key / Length: 80mm / Balldriver
TL-S001-8015	HEX WRENCH	GRAY	69.0g/pcs	4mm , 5mm , 6mm Allen key / Length: 80mm / Balldriver
TL-S001-8016	HEX WRENCH	BLUE	69.0g/pcs	4mm , 5mm , 6mm Allen key / Length: 80mm / Balldriver
TL-S001-8017	HEX WRENCH	APPLE GREEN	69.0g/pcs	4mm , 5mm , 6mm Allen key / Length: 80mm / Balldriver

PAGE	MODEL		CATEGORY	MODELS	COLOR	WEIGHT	FEATURES	PRICE	ORDER
P6	FR-S001-470		FRAME	RACING	FOURIERS PAINTING		Size : 47mm		
	FR-S001-500		FRAME	RACING	FOURIERS PAINTING		Size : 50mm		
	FR-S001-520		FRAME	RACING	FOURIERS PAINTING		Size : 52mm		
	FR-S001-540		FRAME	RACING	FOURIERS PAINTING		Size : 54mm		
	FR-S001-560		FRAME	RACING	FOURIERS PAINTING		Size : 56mm		
	FR-S001-580		FRAME	RACING	FOURIERS PAINTING		Size : 58mm		
	FR-S001-610		FRAME	RACING	FOURIERS PAINTING		Size : 61mm		
P8	SM-RA001-801		STEM	ROAD or MTB	BLACK	131.0g/pcs	DEGREE : ±8° / LENGTH : 80mm For Fork 1-1/4" / Bar-bore 35mm / With carbon shim		
	SM-RA001-901		STEM	ROAD or MTB	BLACK	135.0g/pcs	DEGREE : ±8° / LENGTH : 90mm For Fork 1-1/4" / Bar-bore 35mm / With carbon shim		
	SM-RA001-1001		STEM	ROAD or MTB	BLACK	137.0g/pcs	DEGREE : ±8° / LENGTH : 100mm For Fork 1-1/4" / Bar-bore 35mm / With carbon shim		
	SM-RA001-1101		STEM	ROAD or MTB	BLACK	141.5g/pcs	DEGREE : ±8° / LENGTH : 110mm For Fork 1-1/4" / Bar-bore 35mm / With carbon shim		
	SM-RA001-1201		STEM	ROAD or MTB	BLACK	146.0g/pcs	DEGREE : ±8° / LENGTH : 120mm For Fork 1-1/4" / Bar-bore 35mm / With carbon shim		
	SM-RA001-1301		STEM	ROAD or MTB	BLACK	151.0g/pcs	DEGREE : ±8° / LENGTH : 130mm For Fork 1-1/4" / Bar-bore 35mm / With carbon shim		
	SM-RA001-1401		STEM	ROAD or MTB	BLACK	156.0g/pcs	DEGREE : ±8° / LENGTH : 140mm For Fork 1-1/4" / Bar-bore 35mm / With carbon shim		
P10	SM-RA002-801		STEM	ROAD or MTB	BLACK	122.0g/pcs	DEGREE : ±6° / LENGTH : 80mm For Fork 1-1/8" / Bar-bore 31.8mm		
	SM-RA002-901		STEM	ROAD or MTB	BLACK	124.0g/pcs	DEGREE : ±6° / LENGTH : 90mm For Fork 1-1/8" / Bar-bore 31.8mm		
	SM-RA002-1001		STEM	ROAD or MTB	BLACK	128.5g/pcs	DEGREE : ±6° / LENGTH : 100mm For Fork 1-1/8" / Bar-bore 31.8mm		
	SM-RA002-1101		STEM	ROAD or MTB	BLACK	131.5g/pcs	DEGREE : ±6° / LENGTH : 110mm For Fork 1-1/8" / Bar-bore 31.8mm		
	SM-RA002-1201		STEM	ROAD or MTB	BLACK	138.5g/pcs	DEGREE : ±6° / LENGTH : 120mm For Fork 1-1/8" / Bar-bore 31.8mm		
	SM-RA002-1301		STEM	ROAD or MTB	BLACK	140.0g/pcs	DEGREE : ±6° / LENGTH : 130mm For Fork 1-1/8" / Bar-bore 31.8mm		
	SM-RA002-1401		STEM	ROAD or MTB	BLACK	145.0g/pcs	DEGREE : ±6° / LENGTH : 140mm For Fork 1-1/8" / Bar-bore 31.8mm		
P11	SM-MB004-501		STEM	MTB	BLACK	132g/pcs	DEGREE : 0° / LENGTH : 50mm For Fork 1-1/4" / Bar-bore 35mm / With carbon shim		
	SM-MB004-601		STEM	MTB	BLACK	155g/pcs	DEGREE : 0° / LENGTH : 60mm For Fork 1-1/4" / Bar-bore 35mm / With carbon shim		
	SM-MB004-701		STEM	MTB	BLACK	178g/pcs	DEGREE : 0° / LENGTH : 70mm For Fork 1-1/4" / Bar-bore 35mm / With carbon shim		
	SM-MB004-801		STEM	MTB	BLACK	191g/pcs	DEGREE : 0° / LENGTH : 80mm For Fork 1-1/4" / Bar-bore 35mm / With carbon shim		
	SM-MB004-901		STEM	MTB	BLACK	210g/pcs	DEGREE : 0° / LENGTH : 90mm For Fork 1-1/4" / Bar-bore 35mm / With carbon shim		
	SM-MB004-1001		STEM	MTB	BLACK	228g/pcs	DEGREE : 0° / LENGTH : 100mm For Fork 1-1/4" / Bar-bore 35mm / With carbon shim		
	SM-MB004-1101		STEM	MTB	BLACK	245g/pcs	DEGREE : 0° / LENGTH : 110mm For Fork 1-1/4" / Bar-bore 35mm / With carbon shim		
	SM-MB004-1201		STEM	MTB	BLACK	263g/pcs	DEGREE : 0° / LENGTH : 120mm For Fork 1-1/4" / Bar-bore 35mm / With carbon shim		
	SM-MB004-1301		STEM	MTB	BLACK	282g/pcs	DEGREE : 0° / LENGTH : 130mm For Fork 1-1/4" / Bar-bore 35mm / With carbon shim		
	SM-MB004-1401		STEM	MTB	BLACK	298g/pcs	DEGREE : 0° / LENGTH : 140mm For Fork 1-1/4" / Bar-bore 35mm / With carbon shim		
P12	SM-MB001-501		STEM	DOWNHILL / FREE RIDE / 4X	BLACK	205.0g/pcs	DEGREE : 0° / LENGTH : 50mm For Fork 1-1/4" / Bar-bore 35mm / With carbon shim		
P13	SM-MB002-401		STEM	MTB	BLACK	139.5g/pcs	DEGREE : 0° / LENGTH : 40mm For Fork 1-1/4" / Bar-bore 35mm / With carbon shim		
	SM-MB002-501		STEM	MTB	BLACK	154.5g/pcs	DEGREE : 0° / LENGTH : 50mm For Fork 1-1/4" / Bar-bore 35mm / With carbon shim		
	SM-MB002-601		STEM	MTB	BLACK	173.5g/pcs	DEGREE : 0° / LENGTH : 60mm For Fork 1-1/4" / Bar-bore 35mm / With carbon shim		
	SM-MB002-701		STEM	MTB	BLACK	175.0g/pcs	DEGREE : 0° / LENGTH : 70mm For Fork 1-1/4" / Bar-bore 35mm / With carbon shim		
P14	SM-MB003-001		STEM	DOWNHILL	BLACK	171.0g/pcs	Offset height : 25mm / Bar-bore 35mm Direct mount : boxxer / With carbon shim		





PAGE	MODEL		CATEGORY	MODELS	COLOR	WEIGHT	FEATURES	PRICE	ORDER
P15	HA-S007-5101		STEERING TUBE EXTENDER		S.B BLACK	154g/set	Adjust height 47.5mm ~ 65.5mm / With long screw, spacer, & cap		
	HA-S007-9101		STEERING TUBE EXTENDER		S.B BLACK	192g/set	Adjust height 47.5mm ~ 105.5mm / With long screw, spacer, & cap		
	HA-S007-12101		STEERING TUBE EXTENDER		S.B BLACK	230g/set	Adjust height 47.5mm ~ 135.5mm / With long screw, spacer, & cap		
P16	HB-RA001-400		CARBON HANDLE BAR	RACING	CARBON UD	216.0g	Bar-bore Ø31.8mm x W400mm (c-c) RISE : 130mm / REACH : 80mm Bar tpye : Anatomic-bend		
	HB-RA001-420		CARBON HANDLE BAR	RACING	CARBON UD	220.0g	Bar-bore Ø31.8mm x W420mm (c-c) RISE : 130mm / REACH : 80mm Bar tpye : Anatomic-bend		
	HB-RA001-440		CARBON HANDLE BAR	RACING	CARBON UD	225.0g	Bar-bore Ø31.8mm x W440mm (c-c) RISE : 130mm / REACH : 80mm Bar tpye : Anatomic-bend		
	HB-RA002-400		CARBON HANDLE BAR	RACING	CARBON UD	216.0g	Bar-bore Ø31.8mm x W400mm (c-c) RISE : 130mm / REACH : 80mm Bar tpye : Compact		
	HB-RA002-420		CARBON HANDLE BAR	RACING	CARBON UD	220.0g	Bar-bore Ø31.8mm x W420mm (c-c) RISE : 130mm / REACH : 80mm Bar tpye : Compact		
	HB-RA002-440		CARBON HANDLE BAR	RACING	CARBON UD	225.0g	Bar-bore Ø31.8mm x W440mm (c-c) RISE : 130mm / REACH : 80mm Bar tpye : Compact		
P17	HB-RA003-400		CARBON HANDLE BAR	RACING	CARBON UD	225.0g	Bar-bore Ø35mm x W400mm (c-c) RISE : 128mm / REACH : 78mm Bar tpye : Compact		
	HB-RA003-420		CARBON HANDLE BAR	RACING	CARBON UD	230.0g	Bar-bore Ø35mm x W420mm (c-c) RISE : 128mm / REACH : 78mm Bar tpye : Compact		
	HB-RA003-440		CARBON HANDLE BAR	RACING	CARBON UD	235.0g	Bar-bore Ø35mm x W440mm (c-c) RISE : 128mm / REACH : 78mm Bar tpye : Compact		
P18	HB-MB001-350		CARBON HANDLE BAR	MTB	CARBON UD	279.0g	Bar-bore Ø35mm x W780mm OFFSET : 20mm / Back Sweep : 9° / Up Sweep : 5°		
	HB-MB002-320		CARBON HANDLE BAR	MTB	CARBON UD	273.0g	Bar-bore Ø31.8mm x W780mm (c-c) OFFSET : 20mm / Back Sweep : 9° / Up Sweep : 5°		
	HB-MB003-351		ALLOY HANDLE BAR	MTB	BLACK	427.5g	Bar-bore Ø35mm x W780mm OFFSET : 20mm / Back Sweep : 9° / Up Sweep : 5°		
	HB-MB003-352		ALLOY HANDLE BAR	MTB	SILVER	427.5g	Bar-bore Ø35mm x W780mm OFFSET : 20mm / Back Sweep : 9° / Up Sweep : 5°		
	HB-MB003-353		ALLOY HANDLE BAR	MTB	RED	427.5g	Bar-bore Ø35mm x W780mm OFFSET : 20mm / Back Sweep : 9° / Up Sweep : 5°		
	HB-MB003-354		ALLOY HANDLE BAR	MTB	GOLD	427.5g	Bar-bore Ø35mm x W780mm OFFSET : 20mm / Back Sweep : 9° / Up Sweep : 5°		
	HB-MB003-355		ALLOY HANDLE BAR	MTB	GRAY	427.5g	Bar-bore Ø35mm x W780mm OFFSET : 20mm / Back Sweep : 9° / Up Sweep : 5°		
	HB-MB004-321		ALLOY HANDLE BAR	MTB	BLACK	382.0g	Bar-bore Ø31.8mm x W780mm OFFSET : 20mm / Back Sweep : 9° / Up Sweep : 5°		
	HB-MB004-322		ALLOY HANDLE BAR	MTB	SILVER	382.0g	Bar-bore Ø31.8mm x W780mm OFFSET : 20mm / Back Sweep : 9° / Up Sweep : 5°		
	HB-MB004-323		ALLOY HANDLE BAR	MTB	RED	382.0g	Bar-bore Ø31.8mm x W780mm OFFSET : 20mm / Back Sweep : 9° / Up Sweep : 5°		
	HB-MB004-324		ALLOY HANDLE BAR	MTB	GOLD	382.0g	Bar-bore Ø31.8mm x W780mm OFFSET : 20mm / Back Sweep : 9° / Up Sweep : 5°		
	HB-MB004-325		ALLOY HANDLE BAR	MTB	GRAY	382.0g	Bar-bore Ø31.8mm x W780mm OFFSET : 20mm / Back Sweep : 9° / Up Sweep : 5°		

PAGE	MODEL	IMAGE	CATEGORY	MODELS	COLOR	WEIGHT	FEATURES	PRICE	ORDER
P26	SCL-QE001-S311		SEATCLAMP	All models	S.B BLACK	110g/set	Seat tube Ø31.8mm / With anti-theft system		
	SCL-QE001-S312		SEATCLAMP	All models	S.B SILVER	110g/set	Seat tube Ø31.8mm / With anti-theft system		
	SCL-QE001-S411		SEATCLAMP	All models	S.B BLACK	113g/set	Seat tube Ø34.9mm / With anti-theft system		
	SCL-QE001-S412		SEATCLAMP	All models	S.B SILVER	113g/set	Seat tube Ø34.9mm / With anti-theft system		
P27	QR-DX001-001		QUICK RELEASE	RACING	BLACK	43g/set	O.L.D : (F)100mm (R)130mm		
	QR-DX001-002		QUICK RELEASE	RACING	SILVER	43g/set	O.L.D : (F)100mm (R)130mm		
	QR-DX001-003		QUICK RELEASE	RACING	RED	43g/set	O.L.D : (F)100mm (R)130mm		
	QR-DX001-004		QUICK RELEASE	RACING	GOLD	43g/set	O.L.D : (F)100mm (R)130mm		
	QR-DX001-005		QUICK RELEASE	RACING	GRAY	43g/set	O.L.D : (F)100mm (R)130mm		
	QR-DX001-101		QUICK RELEASE	MTB	BLACK	46g/set	O.L.D : (F)100mm (R)135mm		
	QR-DX001-102		QUICK RELEASE	MTB	SILVER	46g/set	O.L.D : (F)100mm (R)135mm		
	QR-DX001-103		QUICK RELEASE	MTB	RED	46g/set	O.L.D : (F)100mm (R)135mm		
	QR-DX001-104		QUICK RELEASE	MTB	GOLD	46g/set	O.L.D : (F)100mm (R)135mm		
	QR-DX001-105		QUICK RELEASE	MTB	GRAY	46g/set	O.L.D : (F)100mm (R)135mm		
P28	QR-S001-001		QUICK RELEASE	RACING	BLACK	45g/set	O.L.D : (F)100mm (R)130mm		
	QR-S001-002		QUICK RELEASE	RACING	SILVER	45g/set	O.L.D : (F)100mm (R)130mm		
	QR-S001-003		QUICK RELEASE	RACING	RED	45g/set	O.L.D : (F)100mm (R)130mm		
	QR-S001-004		QUICK RELEASE	RACING	GOLD	45g/set	O.L.D : (F)100mm (R)130mm		
	QR-S001-005		QUICK RELEASE	RACING	GRAY	45g/set	O.L.D : (F)100mm (R)130mm		
	QR-S001-101		QUICK RELEASE	MTB	BLACK	47g/set	O.L.D : (F)100mm (R)135mm		
	QR-S001-102		QUICK RELEASE	MTB	SILVER	47g/set	O.L.D : (F)100mm (R)135mm		
	QR-S001-103		QUICK RELEASE	MTB	RED	47g/set	O.L.D : (F)100mm (R)135mm		
	QR-S001-104		QUICK RELEASE	MTB	GOLD	47g/set	O.L.D : (F)100mm (R)135mm		
	QR-S001-105		QUICK RELEASE	MTB	GRAY	47g/set	O.L.D : (F)100mm (R)135mm		
	QR-S002-001		QUICK RELEASE	RACING	BLACK	53g/set	O.L.D : (F)100mm (R)130mm		
	QR-S002-002		QUICK RELEASE	RACING	SILVER	53g/set	O.L.D : (F)100mm (R)130mm		
	QR-S002-003		QUICK RELEASE	RACING	RED	53g/set	O.L.D : (F)100mm (R)130mm		
	QR-S002-004		QUICK RELEASE	RACING	GOLD	53g/set	O.L.D : (F)100mm (R)130mm		
	QR-S002-005		QUICK RELEASE	RACING	GRAY	53g/set	O.L.D : (F)100mm (R)130mm		
QR-S002-101	QUICK RELEASE	MTB	BLACK	56g/set	O.L.D : (F)100mm (R)135mm				
QR-S002-102	QUICK RELEASE	MTB	SILVER	56g/set	O.L.D : (F)100mm (R)135mm				
QR-S002-103	QUICK RELEASE	MTB	RED	56g/set	O.L.D : (F)100mm (R)135mm				
QR-S002-104	QUICK RELEASE	MTB	GOLD	56g/set	O.L.D : (F)100mm (R)135mm				
QR-S002-105	QUICK RELEASE	MTB	GRAY	56g/set	O.L.D : (F)100mm (R)135mm				







PAGE	MODEL	IMAGE	CATEGORY	MODELS	COLOR	WEIGHT	FEATURES	PRICE	ORDER
P29	QR-S003-101		QUICK RELEASE	MTB	BLACK	75g/pcs	Fix SHIMANO Ø12mm · 142mmHUB		
	QR-S003-103		QUICK RELEASE	MTB	RED	75g/pcs	Fix SHIMANO Ø12mm · 142mmHUB		
	QR-E001-001		QUICK RELEASE	RACING	BLACK	112g/set	O.L.D : (F)100mm (R)130mm		
	QR-E001-002		QUICK RELEASE	RACING	SILVER	112g/set	O.L.D : (F)100mm (R)130mm		
	QR-E001-101		QUICK RELEASE	MTB	BLACK	115g/set	O.L.D : (F)100mm (R)135mm		
QR-E001-102	QUICK RELEASE	MTB	SILVER	115g/set	O.L.D : (F)100mm (R)135mm				
P32	BR-DX001-001		BRAKE	RACING	BLACK	210g/set	REACH : C-C 39~51mm		
	BR-DX001-002		BRAKE	RACING	SILVER	210g/set	REACH : C-C 39~51mm		
	BR-DX001-003		BRAKE	RACING	RED	210g/set	REACH : C-C 39~51mm		
	BR-DX001-004		BRAKE	RACING	GOLD	210g/set	REACH : C-C 39~51mm		
	BR-DX001-005		BRAKE	RACING	GRAY	210g/set	REACH : C-C 39~51mm		
	BR-S003-001		BRAKE	RACING	BLACK	230g/set	REACH : C-C 39~51mm		
	BR-S003-002		BRAKE	RACING	SILVER	230g/set	REACH : C-C 39~51mm		
	BR-S003-003		BRAKE	RACING	RED	230g/set	REACH : C-C 39~51mm		
	BR-S003-004		BRAKE	RACING	GOLD	230g/set	REACH : C-C 39~51mm		
	BR-S003-005		BRAKE	RACING	GRAY	230g/set	REACH : C-C 39~51mm		
P33	BR-DX002-001		V-BRAKE	MTB	BLACK	300g/set	ALLOY 7075-T6 , ARM LENGTH 98mm		
	BR-DX002-002		V-BRAKE	MTB	SILVER	300g/set	ALLOY 7075-T6 , ARM LENGTH 98mm		
	BR-DX002-003		V-BRAKE	MTB	RED	300g/set	ALLOY 7075-T6 , ARM LENGTH 98mm		
	BR-DX002-004		V-BRAKE	MTB	GOLD	300g/set	ALLOY 7075-T6 , ARM LENGTH 98mm		
	BR-DX002-005		V-BRAKE	MTB	GRAY	300g/set	ALLOY 7075-T6 , ARM LENGTH 98mm		
P34	BR-S001-101		CANTI-BRAKE	CYCLO CROSS	BLACK	205g/set	ARM LENGTH (F) 46mm (R) 46mm		
	BR-S001-102		CANTI-BRAKE	CYCLO CROSS	SILVER	205g/set	ARM LENGTH (F) 46mm (R) 46mm		
	BR-S001-103		CANTI-BRAKE	CYCLO CROSS	RED	205g/set	ARM LENGTH (F) 46mm (R) 46mm		
	BR-S002-101		CANTI-BRAKE	CYCLO CROSS	BLACK	210g/set	ARM LENGTH (F) 65mm (R) 76mm		
	BR-S002-102		CANTI-BRAKE	CYCLO CROSS	SILVER	210g/set	ARM LENGTH (F) 65mm (R) 76mm		
	BR-S002-103		CANTI-BRAKE	CYCLO CROSS	RED	210g/set	ARM LENGTH (F) 65mm (R) 76mm		
P35	BR-DX003-001		LEVER	V-BRAKE SYSTEM	BLACK	70g/pair	Fix SHIMANO standard brake cable		
	BR-DX003-003		LEVER	V-BRAKE SYSTEM	RED	70g/pair	Fix SHIMANO standard brake cable		
	BR-DX004-001		LEVER	CANTI-BRAKE SYSTEM	BLACK	85g/pair	Fix SHIMANO standard brake cable		
	BR-DX004-003		LEVER	CANTI-BRAKE SYSTEM	RED	85g/pair	Fix SHIMANO standard brake cable		
P36	BR-E001-001		BRAKE SHOES	ROAD BIKE	BLACK	59g/set	Fix SHIMANO		
	BR-E001-002		BRAKE SHOES	ROAD BIKE	SILVER	59g/set	Fix SHIMANO		
	BR-E001-003		BRAKE SHOES	ROAD BIKE	RED	59g/set	Fix SHIMANO		
	BR-E002-001		BRAKE SHOES	CYCLO CROSS	BLACK	77g/set	Fix CANTI-BRAKE/ Offset +5mm		
	BR-E002-002		BRAKE SHOES	CYCLO CROSS	SILVER	77g/set	Fix CANTI-BRAKE/ Offset +5mm		
	BR-E002-003		BRAKE SHOES	CYCLO CROSS	RED	77g/set	Fix CANTI-BRAKE/ Offset +5mm		
	BR-E003-001		BRAKE SHOES	CYCLO CROSS	BLACK	77g/set	Fix CANTI-BRAKE/ Offset -5mm		
	BR-E003-002		BRAKE SHOES	CYCLO CROSS	SILVER	77g/set	Fix CANTI-BRAKE/ Offset -5mm		
	BR-E003-003		BRAKE SHOES	CYCLO CROSS	RED	77g/set	Fix CANTI-BRAKE/ Offset -5mm		

PAGE	MODEL	IMAGE	CATEGORY	MODELS	COLOR	WEIGHT	FEATURES	PRICE	ORDER
P47	TC-S001-001		TOP CAP	All models	BLACK	23g/pcs	FIX 1-1/8" FORK / With stainless bolt		
	TC-S001-002		TOP CAP	All models	SILVER	23g/pcs	FIX 1-1/8" FORK / With stainless bolt		
	TC-S002-100		TOP CAP	All models	3K	14g/pcs	FIX 1-1/8" FORK / With stainless bolt		
	TC-S002-200		TOP CAP	All models	CARBON UD	14g/pcs	FIX 1-1/8" FORK / With stainless bolt		
	TC-E001-001		TOP CAP	All models	BLACK	14.5g/pcs	FIX 1-1/8" FORK / With stainless bolt		
	TC-E001-002		TOP CAP	All models	SILVER	14.5g/pcs	FIX 1-1/8" FORK / With stainless bolt		
	TC-E001-003		TOP CAP	All models	RED	14.5g/pcs	FIX 1-1/8" FORK / With stainless bolt		
	TC-E001-004		TOP CAP	All models	GOLD	14.5g/pcs	FIX 1-1/8" FORK / With stainless bolt		
	TC-E001-005		TOP CAP	All models	GRAY	14.5g/pcs	FIX 1-1/8" FORK / With stainless bolt		
	TC-E001-006		TOP CAP	All models	BLUE	14.5g/pcs	FIX 1-1/8" FORK / With stainless bolt		
TC-E001-007	TOP CAP		All models	APPLE GREEN	14.5g/pcs	FIX 1-1/8" FORK / With stainless bolt			
TC-E001-008	TOP CAP		All models	ORANGE	14.5g/pcs	FIX 1-1/8" FORK / With stainless bolt			
TC-E001-009	TOP CAP		All models	VIOLET	14.5g/pcs	FIX 1-1/8" FORK / With stainless bolt			
TC-E001-010	TOP CAP		All models	GREEN	14.5g/pcs	FIX 1-1/8" FORK / With stainless bolt			
P48	HA-S003-001		EXPANDER	Ø31.8 CARBON FORK	BLACK	56g/set	FIX 1-1/4" FORK		
	HA-S003-002		EXPANDER	Ø31.8 CARBON FORK	SILVER	56g/set	FIX 1-1/4" FORK		
	HA-S003-003		EXPANDER	Ø31.8 CARBON FORK	RED	56g/set	FIX 1-1/4" FORK		
	HA-S003-004		EXPANDER	Ø31.8 CARBON FORK	GOLD	56g/set	FIX 1-1/4" FORK		
	HA-S003-005		EXPANDER	Ø31.8 CARBON FORK	GRAY	56g/set	FIX 1-1/4" FORK		
	HA-S005-001		EXPANDER	Ø28.6 CARBON FORK	BLACK	62g/set	FIX 1-1/8" FORK		
	HA-S005-002		EXPANDER	Ø28.6 CARBON FORK	SILVER	62g/set	FIX 1-1/8" FORK		
	HA-S005-003		EXPANDER	Ø28.6 CARBON FORK	RED	62g/set	FIX 1-1/8" FORK		
	HA-S005-004		EXPANDER	Ø28.6 CARBON FORK	GOLD	62g/set	FIX 1-1/8" FORK		
	HA-S005-005		EXPANDER	Ø28.6 CARBON FORK	GRAY	62g/set	FIX 1-1/8" FORK		
P49	HA-S004-001		TOP CAP	FOR ALLOY or CR-MO STEEL FORK	BLACK	23.5g/set	FIX 1-1/4" FORK / With Star nut		
	HA-S004-002		TOP CAP	FOR ALLOY or CR-MO STEEL FORK	SILVER	23.5g/set	FIX 1-1/4" FORK / With Star nut		
	HA-S004-003		TOP CAP	FOR ALLOY or CR-MO STEEL FORK	RED	23.5g/set	FIX 1-1/5" FORK / With Star nut		
	HA-S004-004		TOP CAP	FOR ALLOY or CR-MO STEEL FORK	GOLD	23.5g/set	FIX 1-1/6" FORK / With Star nut		
	HA-S004-005		TOP CAP	FOR ALLOY or CR-MO STEEL FORK	GRAY	23.5g/set	FIX 1-1/6" FORK / With Star nut		
	HA-S006-001		TOP CAP	FOR ALLOY or CR-MO STEEL FORK	BLACK	24.5g/set	FIX 1-1/8" FORK / With Star nut		
	HA-S006-002		TOP CAP	FOR ALLOY or CR-MO STEEL FORK	SILVER	24.5g/set	FIX 1-1/8" FORK / With Star nut		
	HA-S006-003		TOP CAP	FOR ALLOY or CR-MO STEEL FORK	RED	24.5g/set	FIX 1-1/8" FORK / With Star nut		
	HA-S006-004		TOP CAP	FOR ALLOY or CR-MO STEEL FORK	GOLD	24.5g/set	FIX 1-1/8" FORK / With Star nut		
	HA-S006-005		TOP CAP	FOR ALLOY or CR-MO STEEL FORK	GRAY	24.5g/set	FIX 1-1/8" FORK / With Star nut		
HA-S008		HEADSET	RACING	S.B BLACK	78g/set	INTEGRATED : 1-1/8" upper / 1.5" bottom			
HA-S009		HEADSET	RACING	S.B BLACK	85g/set	INTEGRATED : 1-1/8" upper / 1-1/8" bottom			

PAGE	MODEL	IMAGE	CATEGORY	MODELS	COLOR	WEIGHT	FEATURES	PRICE	ORDER		
P50	SR-S003-001		NYLON SPACER	All models	BLACK	7.2g/set	FIX 1-1/8" FORK / 10mm x 1 + 5mm x 2				
	SR-S003-006		NYLON SPACER	All models	BLUE	7.2g/set	FIX 1-1/8" FORK / 10mm x 1 + 5mm x 2				
	SR-S003-007		NYLON SPACER	All models	LIGHT GREEN	7.2g/set	FIX 1-1/8" FORK / 10mm x 1 + 5mm x 2				
	SR-S003-008		NYLON SPACER	All models	ORANGE	7.2g/set	FIX 1-1/8" FORK / 10mm x 1 + 5mm x 2				
	SR-S003-009		NYLON SPACER	All models	VIOLET	7.2g/set	FIX 1-1/8" FORK / 10mm x 1 + 5mm x 2				
	SR-S003-010		NYLON SPACER	All models	GREEN	7.2g/set	FIX 1-1/8" FORK / 10mm x 1 + 5mm x 2				
	SR-S003-011		NYLON SPACER	All models	LIGHT PINK	7.2g/set	FIX 1-1/8" FORK / 10mm x 1 + 5mm x 2				
	SR-S003-012		NYLON SPACER	All models	WHITE	7.2g/set	FIX 1-1/8" FORK / 10mm x 1 + 5mm x 2				
	SR-S003-013		NYLON SPACER	All models	CLEAR	7.2g/set	FIX 1-1/8" FORK / 10mm x 1 + 5mm x 2				
	SR-S003-014		NYLON SPACER	All models	LIGHT ORANGE	7.2g/set	FIX 1-1/8" FORK / 10mm x 1 + 5mm x 2				
	P51		SR-S001-100		CARBON SPACER	All models	3K	10.5g/set	FIX 1-1/8" FORK		
			SR-S002-100		CARBON SPACER	All models	3K	8.3g/set	FIX 1-1/8" FORK		
			SR-E001-001		ALLOY SPACER	All models	BLACK	15.5g/set	FIX 1-1/8" FORK		
			SR-E001-002		ALLOY SPACER	All models	SILVER	15.5g/set	FIX 1-1/8" FORK		
SR-E002-001			ALLOY SPACER	All models	BLACK	10.5g/set	FIX 1-1/8" FORK				
SR-E002-002			ALLOY SPACER	All models	SILVER	10.5g/set	FIX 1-1/8" FORK				
P52	CR-DX001-441		CHAIN RING		BLACK		Teeth : 44T / Height : 3mm / P.C.D : 130mm / 5 arm for single speed				
	CR-DX001-451		CHAIN RING		BLACK		Teeth : 45T / Height : 3mm / P.C.D : 130mm / 5 arm for single speed				
	CR-DX001-461		CHAIN RING		BLACK		Teeth : 46T / Height : 3mm / P.C.D : 130mm / 5 arm for single speed				
	CR-DX001-471		CHAIN RING		BLACK		Teeth : 47T / Height : 3mm / P.C.D : 130mm / 5 arm for single speed				
	CR-DX001-481		CHAIN RING		BLACK		Teeth : 48T / Height : 3mm / P.C.D : 130mm / 5 arm for single speed				
	CR-DX001-491		CHAIN RING		BLACK		Teeth : 49T / Height : 3mm / P.C.D : 130mm / 5 arm for single speed				
	CR-DX001-501		CHAIN RING		BLACK		Teeth : 50T / Height : 3mm / P.C.D : 130mm / 5 arm for single speed				
	CR-DX001-511		CHAIN RING		BLACK		Teeth : 51T / Height : 3mm / P.C.D : 130mm / 5 arm for single speed				
	CR-DX001-521		CHAIN RING		BLACK		Teeth : 52T / Height : 3mm / P.C.D : 130mm / 5 arm for single speed				
	CR-DX001-531		CHAIN RING		BLACK		Teeth : 53T / Height : 3mm / P.C.D : 130mm / 5 arm for single speed				
	CR-DX001-442		CHAIN RING		SILVER		Teeth : 44T / Height : 3mm / P.C.D : 130mm / 5 arm for single speed				
	CR-DX001-452		CHAIN RING		SILVER		Teeth : 45T / Height : 3mm / P.C.D : 130mm / 5 arm for single speed				
	CR-DX001-462		CHAIN RING		SILVER		Teeth : 46T / Height : 3mm / P.C.D : 130mm / 5 arm for single speed				
	CR-DX001-472		CHAIN RING		SILVER		Teeth : 47T / Height : 3mm / P.C.D : 130mm / 5 arm for single speed				
	CR-DX001-482		CHAIN RING		SILVER		Teeth : 48T / Height : 3mm / P.C.D : 130mm / 5 arm for single speed				
	CR-DX001-492		CHAIN RING		SILVER		Teeth : 49T / Height : 3mm / P.C.D : 130mm / 5 arm for single speed				
	CR-DX001-502		CHAIN RING		SILVER		Teeth : 50T / Height : 3mm / P.C.D : 130mm / 5 arm for single speed				
	CR-DX001-512		CHAIN RING		SILVER		Teeth : 51T / Height : 3mm / P.C.D : 130mm / 5 arm for single speed				
CR-DX001-522	CHAIN RING		SILVER		Teeth : 52T / Height : 3mm / P.C.D : 130mm / 5 arm for single speed						

PAGE	MODEL		CATEGORY	MODELS	COLOR	WEIGHT	FEATURES	PRICE	ORDER
P58	BN-M002-001		WATER BOTTLE CAGE BOLT	All models	BLACK	2.6g/set	M5x0.8 / Length : 10mm / 4mm Allen key / 1set = 2pcs		
	BN-M002-002		WATER BOTTLE CAGE BOLT	All models	SILVER	2.6g/set	M5x0.8 / Length : 10mm / 4mm Allen key / 1set = 2pcs		
	BN-M002-003		WATER BOTTLE CAGE BOLT	All models	RED	2.6g/set	M5x0.8 / Length : 10mm / 4mm Allen key / 1set = 2pcs		
	BN-M002-004		WATER BOTTLE CAGE BOLT	All models	GOLD	2.6g/set	M5x0.8 / Length : 10mm / 4mm Allen key / 1set = 2pcs		
	BN-M002-005		WATER BOTTLE CAGE BOLT	All models	GRAY	2.6g/set	M5x0.8 / Length : 10mm / 4mm Allen key / 1set = 2pcs		
	BN-M002-006		WATER BOTTLE CAGE BOLT	All models	BLUE	2.6g/set	M5x0.8 / Length : 10mm / 4mm Allen key / 1set = 2pcs		
	BN-M002-007		WATER BOTTLE CAGE BOLT	All models	APPLE GREEN	2.6g/set	M5x0.8 / Length : 10mm / 4mm Allen key / 1set = 2pcs		
	BN-M002-008		WATER BOTTLE CAGE BOLT	All models	ORANGE	2.6g/set	M5x0.8 / Length : 10mm / 4mm Allen key / 1set = 2pcs		
	BN-M002-009		WATER BOTTLE CAGE BOLT	All models	VIOLET	2.6g/set	M5x0.8 / Length : 10mm / 4mm Allen key / 1set = 2pcs		
	BN-M002-010		WATER BOTTLE CAGE BOLT	All models	GREEN	2.6g/set	M5x0.8 / Length : 10mm / 4mm Allen key / 1set = 2pcs		
P58	BN-M003-001		WATER BOTTLE CAGE BOLT	All models	BLACK	2.6g/set	M5x0.8 / Length : 10mm / 4mm Allen key / 1set = 2pcs		
	BN-M003-002		WATER BOTTLE CAGE BOLT	All models	SILVER	2.6g/set	M5x0.8 / Length : 10mm / 4mm Allen key / 1set = 2pcs		
	BN-M003-003		WATER BOTTLE CAGE BOLT	All models	RED	2.6g/set	M5x0.8 / Length : 10mm / 4mm Allen key / 1set = 2pcs		
	BN-M003-004		WATER BOTTLE CAGE BOLT	All models	GOLD	2.6g/set	M5x0.8 / Length : 10mm / 4mm Allen key / 1set = 2pcs		
	BN-M003-005		WATER BOTTLE CAGE BOLT	All models	GRAY	2.6g/set	M5x0.8 / Length : 10mm / 4mm Allen key / 1set = 2pcs		
	BN-M003-006		WATER BOTTLE CAGE BOLT	All models	BLUE	2.6g/set	M5x0.8 / Length : 10mm / 4mm Allen key / 1set = 2pcs		
	BN-M003-007		WATER BOTTLE CAGE BOLT	All models	APPLE GREEN	2.6g/set	M5x0.8 / Length : 10mm / 4mm Allen key / 1set = 2pcs		
	BN-M003-008		WATER BOTTLE CAGE BOLT	All models	ORANGE	2.6g/set	M5x0.8 / Length : 10mm / 4mm Allen key / 1set = 2pcs		
	BN-M003-009		WATER BOTTLE CAGE BOLT	All models	VIOLET	2.6g/set	M5x0.8 / Length : 10mm / 4mm Allen key / 1set = 2pcs		
	BN-M003-010		WATER BOTTLE CAGE BOLT	All models	GREEN	2.6g/set	M5x0.8 / Length : 10mm / 4mm Allen key / 1set = 2pcs		
P59	BN-TA001		BOLT	All models	TITANIUM	4.5g/set	M5x0.8 / Length : 15mm / 4mm Allen key / 1set = 2pcs		
	BN-TA002		BOLT	All models	TITANIUM	5.0g/set	M5x0.8 / Length : 18mm / 4mm Allen key / 1set = 2pcs		
	BN-TA003		BOLT	All models	TITANIUM	4.0g/set	M5x0.8 / Length : 12mm / 4mm Allen key / 1set = 2pcs		

PAGE	MODEL		CATEGORY	MODELS	COLOR	WEIGHT	FEATURES	PRICE	ORDER
P60	VL-PE001-251		VALVE EXTENDER	Presta inner tube	BLACK	2.2g/set	Length : 25mm / 1set = 2pcs		
	VL-PE001-381		VALVE EXTENDER	Presta inner tube	BLACK	4.0g/set	Length : 38mm / 1set = 2pcs		
	VL-PE001-501		VALVE EXTENDER	Presta inner tube	BLACK	6.0g/set	Length : 50mm / 1set = 2pcs		
	VL-PE001-601		VALVE EXTENDER	Presta inner tube	BLACK	8.0g/set	Length : 60mm / 1set = 2pcs		
	VL-PE001-701		VALVE EXTENDER	Presta inner tube	BLACK	10.0g/set	Length : 70mm / 1set = 2pcs		
	VL-PE001-801		VALVE EXTENDER	Presta inner tube	BLACK	12.0g/set	Length : 80mm / 1set = 2pcs		
	VL-PE001-901		VALVE EXTENDER	Presta inner tube	BLACK	14.0g/set	Length : 90mm / 1set = 2pcs		
	VL-PE001-1001		VALVE EXTENDER	Presta inner tube	BLACK	16.0g/set	Length : 100mm / 1set = 2pcs		
	VL-PE001-252		VALVE EXTENDER	Presta inner tube	SILVER	2.2g/set	Length : 25mm / 1set = 2pcs		
	VL-PE001-382		VALVE EXTENDER	Presta inner tube	SILVER	4.0g/set	Length : 38mm / 1set = 2pcs		
	VL-PE001-502		VALVE EXTENDER	Presta inner tube	SILVER	6.0g/set	Length : 50mm / 1set = 2pcs		
	VL-PE001-602		VALVE EXTENDER	Presta inner tube	SILVER	8.0g/set	Length : 60mm / 1set = 2pcs		
	VL-PE001-702		VALVE EXTENDER	Presta inner tube	SILVER	10.0g/set	Length : 70mm / 1set = 2pcs		
	VL-PE001-802		VALVE EXTENDER	Presta inner tube	SILVER	12.0g/set	Length : 80mm / 1set = 2pcs		
	VL-PE001-902		VALVE EXTENDER	Presta inner tube	SILVER	14.0g/set	Length : 90mm / 1set = 2pcs		
	VL-PE001-1002		VALVE EXTENDER	Presta inner tube	SILVER	16.0g/set	Length : 100mm / 1set = 2pcs		
	VL-PE002-201		VALVE EXTENDER	Presta inner tube	BLACK	2.2g/set	Length : 20mm / 1set = 2pcs + Tool x 1pcs		
	VL-PE002-301		VALVE EXTENDER	Presta inner tube	BLACK	3.4g/set	Length : 30mm / 1set = 2pcs + Tool x 1pcs		
	VL-PE002-401		VALVE EXTENDER	Presta inner tube	BLACK	4.8g/set	Length : 40mm / 1set = 2pcs + Tool x 1pcs		
	VL-PE002-501		VALVE EXTENDER	Presta inner tube	BLACK	6.0g/set	Length : 50mm / 1set = 2pcs + Tool x 1pcs		
VL-PE002-601		VALVE EXTENDER	Presta inner tube	BLACK	7.2g/set	Length : 60mm / 1set = 2pcs + Tool x 1pcs			
VL-PE002-701		VALVE EXTENDER	Presta inner tube	BLACK	8.4g/set	Length : 70mm / 1set = 2pcs + Tool x 1pcs			
VL-PE002-801		VALVE EXTENDER	Presta inner tube	BLACK	9.6g/set	Length : 80mm / 1set = 2pcs + Tool x 1pcs			
VL-PE002-901		VALVE EXTENDER	Presta inner tube	BLACK	10.8g/set	Length : 90mm / 1set = 2pcs + Tool x 1pcs			
VL-PE002-1001		VALVE EXTENDER	Presta inner tube	BLACK	12.0g/set	Length : 100mm / 1set = 2pcs + Tool x 1pcs			
VL-PE002-202		VALVE EXTENDER	Presta inner tube	SILVER	2.2g/set	Length : 20mm / 1set = 2pcs + Tool x 1pcs			
VL-PE002-302		VALVE EXTENDER	Presta inner tube	SILVER	3.4g/set	Length : 30mm / 1set = 2pcs + Tool x 1pcs			
VL-PE002-402		VALVE EXTENDER	Presta inner tube	SILVER	4.8g/set	Length : 40mm / 1set = 2pcs + Tool x 1pcs			
VL-PE002-502		VALVE EXTENDER	Presta inner tube	SILVER	6.0g/set	Length : 50mm / 1set = 2pcs + Tool x 1pcs			
VL-PE002-602		VALVE EXTENDER	Presta inner tube	SILVER	7.2g/set	Length : 60mm / 1set = 2pcs + Tool x 1pcs			
VL-PE002-702		VALVE EXTENDER	Presta inner tube	SILVER	8.4g/set	Length : 70mm / 1set = 2pcs + Tool x 1pcs			
VL-PE002-802		VALVE EXTENDER	Presta inner tube	SILVER	9.6g/set	Length : 80mm / 1set = 2pcs + Tool x 1pcs			
VL-PE002-902		VALVE EXTENDER	Presta inner tube	SILVER	10.8g/set	Length : 90mm / 1set = 2pcs + Tool x 1pcs			
VL-PE002-1002		VALVE EXTENDER	Presta inner tube	SILVER	12.0g/set	Length : 100mm / 1set = 2pcs + Tool x 1pcs			

PAGE	MODEL		CATEGORY	MODELS	COLOR	WEIGHT	FEATURES	PRICE	ORDER
P60	VL-PE003-301		VALVE EXTENDER	Vittoria inner tube	BLACK	4.2g/set	Length : 30mm / 1set = 2pcs + Tool x 1pcs		
	VL-PE003-401		VALVE EXTENDER	Vittoria inner tube	BLACK	5.6g/set	Length : 40mm / 1set = 2pcs + Tool x 1pcs		
	VL-PE003-501		VALVE EXTENDER	Vittoria inner tube	BLACK	7.0g/set	Length : 50mm / 1set = 2pcs + Tool x 1pcs		
	VL-PE003-601		VALVE EXTENDER	Vittoria inner tube	BLACK	8.6g/set	Length : 60mm / 1set = 2pcs + Tool x 1pcs		
	VL-PE003-701		VALVE EXTENDER	Vittoria inner tube	BLACK	10.2g/set	Length : 70mm / 1set = 2pcs + Tool x 1pcs		
	VL-PE003-302		VALVE EXTENDER	Vittoria inner tube	SILVER	4.2g/set	Length : 30mm / 1set = 2pcs + Tool x 1pcs		
	VL-PE003-402		VALVE EXTENDER	Vittoria inner tube	SILVER	5.6g/set	Length : 40mm / 1set = 2pcs + Tool x 1pcs		
	VL-PE003-502		VALVE EXTENDER	Vittoria inner tube	SILVER	7.0g/set	Length : 50mm / 1set = 2pcs + Tool x 1pcs		
	VL-PE003-602		VALVE EXTENDER	Vittoria inner tube	SILVER	8.6g/set	Length : 60mm / 1set = 2pcs + Tool x 1pcs		
	VL-PE003-702		VALVE EXTENDER	Vittoria inner tube	SILVER	10.2g/set	Length : 70mm / 1set = 2pcs + Tool x 1pcs		
P61	VL-PE004-001		VALVE CAP	Presta inner tube	BLACK	2.9g/set	Presta 12# x 24 / 1set = 2pcs		
	VL-PE004-002		VALVE CAP	Presta inner tube	SILVER	2.9g/set	Presta 12# x 24 / 1set = 2pcs		
	VL-PE004-003		VALVE CAP	Presta inner tube	RED	2.9g/set	Presta 12# x 24 / 1set = 2pcs		
	VL-PE004-004		VALVE CAP	Presta inner tube	GOLD	2.9g/set	Presta 12# x 24 / 1set = 2pcs		
	VL-PE004-005		VALVE CAP	Presta inner tube	GRAY	2.9g/set	Presta 12# x 24 / 1set = 2pcs		
	VL-PE004-006		VALVE CAP	Presta inner tube	BLUE	2.9g/set	Presta 12# x 24 / 1set = 2pcs		
	VL-PE004-007		VALVE CAP	Presta inner tube	APPLE GREEN	2.9g/set	Presta 12# x 24 / 1set = 2pcs		
	VL-PE004-008		VALVE CAP	Presta inner tube	ORANGE	2.9g/set	Presta 12# x 24 / 1set = 2pcs		
VL-PE005-001		Valve Adapter	DISC inner tube	BLACK	9.6g/pcs	For Presta valve			
VL-PE006-001		VALVE CAP	Presta inner tube	BLACK	7.0g/set	Presta 12# x 24 / 1set = 2pcs			
VL-PE006-002		VALVE CAP	Presta inner tube	SILVER	7.0g/set	Presta 12# x 24 / 1set = 2pcs			
VL-PE006-003		VALVE CAP	Presta inner tube	RED	7.0g/set	Presta 12# x 24 / 1set = 2pcs			
VL-PE006-004		VALVE CAP	Presta inner tube	GOLD	7.0g/set	Presta 12# x 24 / 1set = 2pcs			
VL-PE006-005		VALVE CAP	Presta inner tube	GRAY	7.0g/set	Presta 12# x 24 / 1set = 2pcs			
VL-PE006-006		VALVE CAP	Presta inner tube	BLUE	7.0g/set	Presta 12# x 24 / 1set = 2pcs			
VL-PE006-007		VALVE CAP	Presta inner tube	APPLE GREEN	7.0g/set	Presta 12# x 24 / 1set = 2pcs			
VL-PE006-008		VALVE CAP	Presta inner tube	ORANGE	7.0g/set	Presta 12# x 24 / 1set = 2pcs			
P62	VL-US003-001		VALVE ADAPTER	USA inner tube	BLACK	2.3g/set	Presta change to USA valve		
	VL-US003-002		VALVE ADAPTER	USA inner tube	SILVER	2.3g/set	Presta change to USA valve		
	VL-US003-003		VALVE ADAPTER	USA inner tube	RED	2.3g/set	Presta change to USA valve		
	VL-US003-004		VALVE ADAPTER	USA inner tube	GOLD	2.3g/set	Presta change to USA valve		
	VL-US003-005		VALVE ADAPTER	USA inner tube	GRAY	2.3g/set	Presta change to USA valve		
VL-US001-001		VALVE CAP	USA inner tube	BLACK	13.0g/set	For USA valve			
VL-US001-002		VALVE CAP	USA inner tube	SILVER	13.0g/set	For USA valve			
VL-US001-003		VALVE CAP	USA inner tube	RED	13.0g/set	For USA valve			
VL-US001-004		VALVE CAP	USA inner tube	GOLD	13.0g/set	For USA valve			
VL-US001-005		VALVE CAP	USA inner tube	GRAY	13.0g/set	For USA valve			
VL-US002-001		VALVE CAP	USA inner tube	BLACK	18.7g/set	For USA valve			
VL-US002-002		VALVE CAP	USA inner tube	SILVER	18.7g/set	For USA valve			
VL-US002-003		VALVE CAP	USA inner tube	RED	18.7g/set	For USA valve			
VL-US002-004		VALVE CAP	USA inner tube	GOLD	18.7g/set	For USA valve			
VL-US002-005		VALVE CAP	USA inner tube	GRAY	18.7g/set	For USA valve			

PAGE	MODEL		CATEGORY	MODELS	COLOR	WEIGHT	FEATURES	PRICE	ORDER
P63	TL-S001-651		TOOL	HEX WRENCH	BLACK	62.5g/pcs	4mm, 5mm, 6mm Allen key / Length : 65mm / Hex wrench		
	TL-S001-653		TOOL	HEX WRENCH	RED	62.5g/pcs	4mm, 5mm, 6mm Allen key / Length : 65mm / Hex wrench		
	TL-S001-655		TOOL	HEX WRENCH	GRAY	62.5g/pcs	4mm, 5mm, 6mm Allen key / Length : 65mm / Hex wrench		
	TL-S001-656		TOOL	HEX WRENCH	BLUE	62.5g/pcs	4mm, 5mm, 6mm Allen key / Length : 65mm / Hex wrench		
	TL-S001-657		TOOL	HEX WRENCH	APPLE GREEN	62.5g/pcs	4mm, 5mm, 6mm Allen key / Length : 65mm / Hex wrench		
	TL-S001-6511		TOOL	HEX WRENCH	BLACK	62.0g/pcs	4mm, 5mm, 6mm Allen key / Length : 65mm / Balldriver		
	TL-S001-6513		TOOL	HEX WRENCH	RED	62.0g/pcs	4mm, 5mm, 6mm Allen key / Length : 65mm / Balldriver		
	TL-S001-6515		TOOL	HEX WRENCH	GRAY	62.0g/pcs	4mm, 5mm, 6mm Allen key / Length : 65mm / Balldriver		
	TL-S001-6516		TOOL	HEX WRENCH	BLUE	62.0g/pcs	4mm, 5mm, 6mm Allen key / Length : 65mm / Balldriver		
	TL-S001-6517		TOOL	HEX WRENCH	APPLE GREEN	62.0g/pcs	4mm, 5mm, 6mm Allen key / Length : 65mm / Balldriver		
	TL-S001-801		TOOL	HEX WRENCH	BLACK	69.5g/pcs	4mm, 5mm, 6mm Allen key / Length : 80mm / Hex wrench		
	TL-S001-803		TOOL	HEX WRENCH	RED	69.5g/pcs	4mm, 5mm, 6mm Allen key / Length : 80mm / Hex wrench		
	TL-S001-805		TOOL	HEX WRENCH	GRAY	69.5g/pcs	4mm, 5mm, 6mm Allen key / Length : 80mm / Hex wrench		
	TL-S001-806		TOOL	HEX WRENCH	BLUE	69.5g/pcs	4mm, 5mm, 6mm Allen key / Length : 80mm / Hex wrench		
	TL-S001-807		TOOL	HEX WRENCH	APPLE GREEN	69.5g/pcs	4mm, 5mm, 6mm Allen key / Length : 80mm / Hex wrench		
	TL-S001-8011		TOOL	HEX WRENCH	BLACK	69.0g/pcs	4mm, 5mm, 6mm Allen key / Length : 80mm / Balldriver		
	TL-S001-8013		TOOL	HEX WRENCH	RED	69.0g/pcs	4mm, 5mm, 6mm Allen key / Length : 80mm / Balldriver		
TL-S001-8015	TOOL	HEX WRENCH	GRAY	69.0g/pcs	4mm, 5mm, 6mm Allen key / Length : 80mm / Balldriver				
TL-S001-8016	TOOL	HEX WRENCH	BLUE	69.0g/pcs	4mm, 5mm, 6mm Allen key / Length : 80mm / Balldriver				
TL-S001-8017	TOOL	HEX WRENCH	APPLE GREEN	69.0g/pcs	4mm, 5mm, 6mm Allen key / Length : 80mm / Balldriver				





www.fouriers-bike.com